



RADIO'S LIVEST MAGAZINE

Special
**METAL
TUBE**
Number

Radio-Craft

October
25 Cents

HUGO GERNSBACK Editor

**X-RAY VIEW
OF NEW
METAL TUBE**
See Page 202



**Characteristic Data on Metal Tubes - The Lazyman "Metal 4" Receiver
Metal Tubes in Test Apparatus - High-Fidelity Amplifiers and Tuners**

Let the Camera, not words, tell the story of speed and service of the Supreme 89 DeLuxe Tube Tester. Here's proof of the 7 in 1 instrument facilities of this master service tool. Single selector switch converts instrument to (1) English Reading Tube Tester, (2) Neon Tube Leakage Tester, (3) Neon Electrostatic Condenser Tester, (4) English Reading Electrolytic Condenser Analyzer, (5) Multi-range Voltmeter, (6) Multi-range Ohmmeter, and (7) a Double Range Megohmmeter. Resistance ranges to 20 megohms are with self contained power supply. This is the instrument that will put a lot of extra profits in servicemen's pockets this season. Price \$45.95.

Demonstration by your jobber gives you vivid realism of the versatility, rapidity and finality inherent in the entire group of 1936 Supreme

Instruments. The free technical manuals, completely diagrammed, disclose the inside story of the minuteness and accuracy with which these instruments are engineered to the practical needs of every day servicing. "The instruments we need to be modernly equipped," say the forward-looking serviceman. "The equipment the real radioman will want," agree leading jobbers as they decide on the lines to get behind in this season of better buying power. Truly "Supreme by Comparison." Other Supreme Instruments include Supreme 89 Standard Tube Tester, \$34.95; Supreme 339 DeLuxe Analyzer \$39.95; Supreme 339 Standard Analyzer \$29.95; Supreme 385 Automatic \$77.95; Supreme 189 Signal Generator \$36.95; Supreme P.A. Analyzer \$69.95. Write Supreme Instruments Corp., Greenwood, Miss., for manual on instruments of your choice.

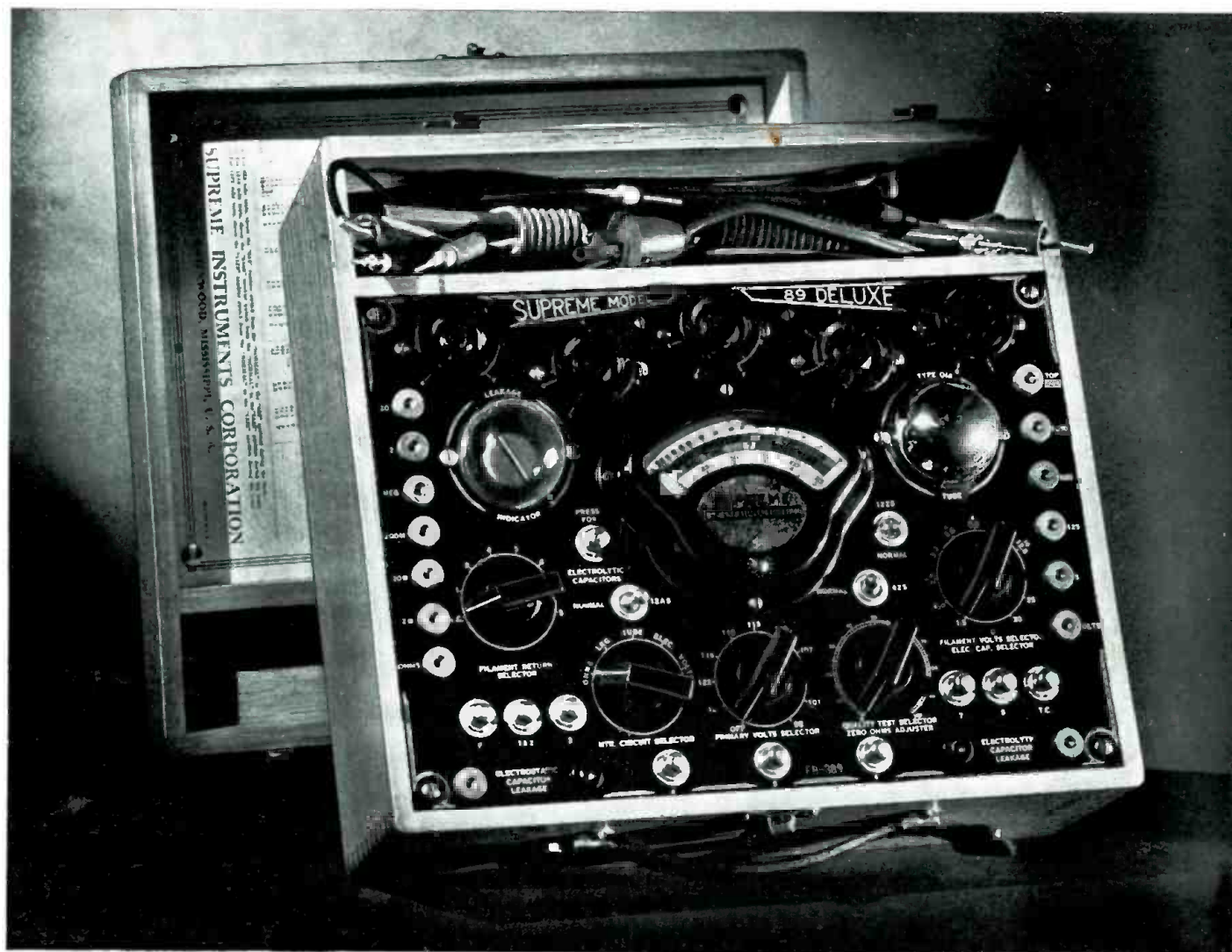



STUDENTS BUSY AT WORK IN GREAT COYNE SHOPS

Learn RADIO

SEND TODAY FOR DETAILS OF MY Pay-Tuition-after-Graduation Plan!

Train for Radio in 12 weeks, right here in the great Coyne Shops — not by correspondence — but on real Radio, Sound and Television equipment. Mail the coupon below. If you are short of money I'll send you all details of my finance plan and consider your application. If accepted, you won't have to start paying tuition back until five months from the date you start school, and then you'll have over a year to complete your payments.

Tremendous Developments Ahead in Radio and Television!

HERE is YOUR opportunity to cash in. Every day brings news of new developments in every branch of Radio and Television, with more opportunities, more jobs, and a greater future for the trained man than ever before. I consider the fellow who is ambitious enough to want to get ahead by taking my Training, worthy of my help. MAIL THE COUPON BELOW and you can prove to me that you are willing to spend just 12 weeks in the Coyne Training Shops learning Radio. Then, I'll tell you about my finance plan which has enabled many to get complete Training and pay tuition back later.

Learn By Doing In 12 Weeks

I don't care whether you are 16 or 45. It makes no difference to me if you don't know an oscillator from a spark coil. You don't need any previous experience or advanced education to master my Shop Training. Don't let Jack of money hold you back from getting all details of my amazing plan.

MANY EARN While LEARNING

If you need part-time work to help pay your living expenses and will tell us your problems we may be able to help you as we have thousands of others. Then, in 12 brief weeks, in the great Training shops of Coyne, you will learn on a wide variety of modern, up-to-date A. C. Super-heterodyne sets, oscillators, analyzers and test instruments. Prepare for Amateur Broadcast, or Telegraph Radio Operator's License and to know all code and Dept. of Commerce rules for a government License Examination.

TRAINING

By Actual Work

No dull books . . . you get individual training . . . real actual work with only the theory you will need. Building real radio sets,



Auto Radio Instruction Prepare For Jobs Like These

Here are a few of hundreds of positions in the Radio field. My free employment bureau gives you life-time employment service.

- AIRCRAFT RADIO OPERATOR
- SHIP RADIO OPERATOR
- RADIO SERVICING
- PUBLIC ADDRESS SYSTEMS
- BROADCAST STATION OPERATOR
- TALKING PICTURE STUDIOS
- TELEVISION LABORATORY MAN



doing radio wiring and testing, trouble-shooting, repairing and servicing. That's a glimpse of how we help to make you a Radio expert, and fit you to qualify for jobs leading to the biggest pay.

Jobs - Pay - Future

"I got my present job two days after graduation, at shorter hours, and wages increased 60% over my old job," reports Arne Wiklem of Minnesota. "I have my own shop, own a real car and make fine money in the radio business," writes E. Allen of Montana, "All this is possible because I came to Coyne." And I could go on quoting from hundreds of letters of successful Coyne Trained men. What they have done, you should be able to do.

Electric Refrigeration Air Conditioning

Right now I'm including my big new Electric Refrigeration and Air Conditioning course at no extra cost.

Home of Coyne Shops

This is our fireproof modern Building wherein is installed thousands of dollars' worth of Radio equipment of all kinds. Every comfort and convenience has been arranged to make you happy and contented during your Training.

GET THE FACTS

Coyne is your one great chance to get into Radio. This school is 36 years old—Coyne training is tested—proven beyond all doubt—endorsed by many large concerns. You can find out everything absolutely free. Simply mail the coupon and let me send you the big, free Coyne Book with photographs . . . facts . . . jobs . . . salaries . . . opportunities. Tells you how many earn expenses while training and how we assist our graduates in the field. This does not obligate you. So act at once. Just mail coupon.

Get this Free Book



H. C. LEWIS, President
Coyne Radio & Electrical School
500 S. Paulina St. Dept. 75-8H, Chicago

Dear Mr. Lewis: Without obligation send me your big free catalog and all details; also tell me all about your "Pay-Tuition-After-Graduation" Plan.

Name.....Age.....
Address.....
City.....State.....

COYNE H. C. LEWIS, President Founded 1899
RADIO & ELECTRICAL SCHOOL
500 South Paulina Street Dept. 75-8H, Chicago, Ill.

Please Say That You Saw It in RADIO-CRAFT



CONTENTS—Oct., 1935, Issue

Volume VII

Number 4

Editorial: Metal Radio Tubes.....	Hugo Gernsback	197
The Radio Month in Review.....		198
Radio Pictorial.....		200
An Inside Story About Metal Tubes....	R. D. Washburne	202
Testing Metal Tubes on a "Beginners' Breadboard".....	Staff	203
New 6L7 Pentagrid "Mixer-Amplifier" Metal Tube.....	C. W. Palmer	204
Making the Lazyman "Metal 4" Receiver.....	N. H. Lessem	205
A Metal-Tube All-Wave Tuner.....	H. R. Williams	206
Metal Tubes in a High-Fidelity Amplifier....	J. B. Carter	207
An 18-Tube All-Wave Superhet.....	W. A. Smith	208
A 3 1/2 W. Metal-Tube A.F. Amplifier.....	Theo. Schmalzriedt	208
An Ultra-Modern Metal Tube Checker.....	O. J. Morelock	209
A New 7-Tube All-Wave Receiver.....	Hubert Shortt	209
A Portable-Type Metal-Tube Checker.....	Milton Reiner	210
A 3-Band Metal-Tube Superheterodyne.....	H. W. Paro	210
These 1935-'36 Receivers Feature Metal Tubes.....		211
The "Metal-Glass" Converter Tube in All-Wave Sets.....	J. E. Whittier	211
A Metal-Tube Combination Tester.....	John W. Million, Jr.	212
The New Bridge-Type Vibrator-"B" Tester.....	Wm. W. Garstang	212
An Oscilloscope Metal-Tube Analyzer-Adapter.....	E. J. Sampson	213
The Sweep Voltage for Cathode-Ray Tubes.....	Alfred A. Ghirardi	213
Metal Versus Glass Radio Tubes.....	A. Bombe	214
The Newest in Treasure Locators....	R. D. Burchard, Jr.	214
Making an All-Wave Service Oscillator....	Michael Blau	215
The Latest Radio Equipment.....		216
How to Make an "EIR" Tester.....	Clifford E. Denton	218
The "Neon" Interference Problem.....	J. Albert Lynch	219
"Ultra-Fidelity" Reproduction.....	L. Mitchell Barcus	220
RADIO-CRAFT'S "Ideal Radio Service Shop" Contest.....		220
International Radio Review.....		221
Short-Cuts in Radio.....		222
The Listening Post for All-Wave DX-ers.....	C. A. Morrison	223
Operating Notes.....		224
ORSMA Members' Forum.....		225
Readers' Department.....		226
RADIO-CRAFT'S Information Bureau.....		227
P.A. Questions and Answers.....	Charles R. Shaw	227
RADIO SERVICE DATA SHEETS:		
No. 147—Characteristics of Metal Tubes—and other "Octal" (8-prong) Base Types.....		228
No. 148—Fada Metal Tube Model 190 All-Wave 10-Tube Receiver.....		230
Technicians' Data Service.....		232

HUGO GERNSBACK, Editor-in-Chief

C. W. PALMER

Associate Editor

H. G. McENTEE

Associate Editor

R. D. WASHBURNE, Technical Editor

RADIO AS A VOCATION— IN OUR NEXT ISSUE

Is it advisable to take up radio "for a living"? Is there any "money" in this field? What are the technical requirements in the various branches of radio and what are the probabilities for success in these fields? The answer is plain—contrary to the opinion of some short-sighted individuals, the possibilities for deriving an independent income from radio activities are *greater now than ever before!*

Consequently, the following VOCATIONAL ISSUE of RADIO-CRAFT will be of unusual interest inasmuch as it will contain specialized articles on *the vocational possibilities* in the fields of public address, automobile radio, television, electronics, broadcasting, commercial radio telegraphy and telephony, set construction, short waves, servicing, etc.

Don't miss this issue!

RADIO-CRAFT is published monthly, on the first of the month preceding that of date; its subscription price is \$2.50 per year. (In Canada and foreign countries, \$3.00 a year to cover additional postage.) Entered at the post office at Mount Morris, Ill., as second-class matter under the act of March 3, 1879.

Text and illustrations of this magazine are copyright and must not be reproduced without permission of the copyright owners. We are also agents for WONDER STORIES and EVERYDAY SCIENCE AND MECHANICS. Subscription to these magazines may be taken in combination with RADIO-CRAFT at reduced Club rates. Write for information.

Copyright 1935. Continental Publications, Inc.

HUGO GERNSBACK, President

I. S. MANHEIMER, Secretary

Published by Continental Publications, Inc. Publication office: 404 N. Wesley Ave., Mount Morris, Illinois. Editorial and Advertising Office: 99 Hudson Street, New York City. Chicago Advertising Office: L. F. McClure, 919 North Michigan Avenue, Chicago, Ill. Western Advertising Office: Loyd B. Chappell, 511 So. Alexandria St., Los Angeles, Calif.

European Agents:

London—Gorrings' American News Agency, 9A Green St., Leicester Square, London, W. C. 2.

Paris—Messageries Dawson, 4 Rue Faubourg, Poissonniere, Paris, France.

Australian Agent: McGill's Agency, 179 Elizabeth St., Melbourne.



J. E. Smith,
President
National Radio
Institute

I WILL TRAIN YOU TO START A FULL TIME OR SPARE TIME RADIO SERVICE BUSINESS WITHOUT CAPITAL

**HERE ARE A FEW EXAMPLES
OF THE KIND OF MONEY
I TRAIN MY MEN TO MAKE**

Now Has Fine Business

"I have a fine business servicing sets. I am making a good living—seldom have a week under \$40. If it wasn't for N. R. I. I would probably be tramping the streets."—GLENN C. KING, 46 Division Ave., S., Grand Rapids, Mich.



\$15 A Week in Spare Time

"My spare time earnings average \$15 a week. Since studying with you I have earned about \$7,000 to \$8,000 in Radio. I owe my success to the good method of the N. R. I."—C. N. HEFFEL-FINGER, R. F. D. No. 1, Temple, Penn.



Best Equipped Shop in Town

"In the last year, we have moved our Radio Shop and we now have the best equipped Radio Repair Shop in East Toledo. We also have a shop at 624 Milton Street. We have three fellows working for us."—W. R. BROWN, 309 Main St., Toledo, Ohio.



You Get PRACTICAL EXPERIENCE with Radio Equipment I Give You

I'll show you how to use my special Radio equipment for conducting experiments and building circuits which illustrate important principles used in such well-known sets as Westinghouse, General Electric, Philco, R.C.A., Victor, Atwater-Kent, and others. You work out with your own hands many of the things you read in our lesson books. This 50-50 method of training makes learning at home easy, interesting, fascinating, intensely practical. You learn how sets work, why they work, how to make them work.



Free Book Tells How Mail Coupon!

The world-wide use of Radio sets for home entertainment has made many opportunities for you to have a spare time or full time Radio service business of your own. The day you enroll I start sending you Extra Money Job Sheets which quickly show you how to do Radio repair jobs common in most every neighborhood. Many N. R. I. men make \$5, \$10, \$15 a week extra in spare time while learning. I show you how to install and service all types of receiving sets. I give you Radio equipment and instructions for conducting experiments, for building circuits and testing equipment, and for making tests that will give you broad, practical Radio experience. Clip the coupon below and get my free 64-page book, "Rich Rewards in Radio"—it gives you a full story of the success of N. R. I. students and graduates, and tells how to start a spare time or full time Radio service business on money made in spare time while learning.

Many N. R. I. Men Make \$5, \$10, \$15 A Week Extra in Spare Time While Learning

Many of the twenty million sets now in use are less than 50% efficient. I will show you how to cash in on this condition. I will show you the plans and ideas that have enabled many others to make \$5, \$10, \$15 a week in spare time while learning. George W. Honert, 248 Water St., Ligonier, Ind., made over \$500 from the start of the Course to its completion.

Get Ready Now for a Radio Business of Your Own and for Jobs Like These

Broadcasting stations use engineers, operators, station managers, and pay up to \$5,000 a year. Radio manufacturers use testers, inspectors, foremen, engineers, servicemen and buyers, and pay up to

\$6,000 a year. Radio dealers and jobbers employ hundreds of servicemen, salesmen, managers, and pay up to \$75 a week. Television promises many good jobs soon. Television is leaving the laboratory in an impressive way. One million dollars is being spent on two stations. Receiving sets are being designed and built. New opportunities—many of them—are right ahead. My book tells you of the opportunities in these fields, also in Aviation Radio, Police Radio, Short Wave Radio, Automobile Radio and other new branches of this fast growing industry. Get it.

I Train You at Home in Your Spare Time

Hold your job until you're ready for another. Give me only part of your spare time. You do not need a high school or college education. Hundreds with only a common school education have won bigger pay through N. R. I. Graduate J. A. Vaughn jumped from \$35 to \$100 a week. Fred Du-buque doubled his earnings in one year. The National Radio Institute is the Pioneer and World's largest organization devoted exclusively to training men by Home Study for good jobs in the Radio industry.

You Must Be Satisfied

I will give you an agreement to refund every penny of your money if you are not satisfied with my Lesson and Instruction Service when you complete my Training. And I'll not only give you thorough training in Radio principles, practical experience in building and servicing sets, but also Advanced Specialized Training in the type of Radio work you choose.

Get My Free Book of Facts

Mail the coupon for "Rich Rewards in Radio." It's free to any ambitious fellow over 15 years old. It tells you about Radio's spare time and full time opportunities; about my training; what others who have taken it are doing and making. Mail coupon now in an envelope, or paste it on a 1c post card.

J. E. SMITH, Pres.
Dept. 5KX
National Radio
Institute
Washington, D. C.



Get My FREE LESSON on Radio Servicing Tips

I'll prove that my Training gives practical money-making information that is easy to understand—that it is just what you need to master Radio. My sample lesson text, "Radio Receiving Troubles—The Cause and Remedy" covers a long list of Radio receiver troubles in A.C., D.C., battery, universal, auto T.R.F., super-heterodyne, all wave, and other types of sets. And a cross reference system gives you the probable cause and a quick way to locate and remedy these set troubles. A special section is devoted to receiver check-up, alignment, balancing, neutralizing and testing. Get this lesson Free. No obligation. Just mail coupon.

MAIL COUPON NOW

This Coupon is Good for One FREE COPY OF MY NEW BOOK

J. E. SMITH, President,
National Radio Institute,
Dept. 5KX,
Washington, D. C.

Dear Mr. Smith: Without obligation, send me the Sample Lesson and you free book about spare time and full time Radio opportunities, and how I can train for them at home in spare time. (Please print plainly.)

Name..... Age.....
Address.....
City..... State.....

Find out about the World Famous Course that Pays for Itself

Please Say That You Saw It in RADIO-CRAFT

14X11

Would You Like to See

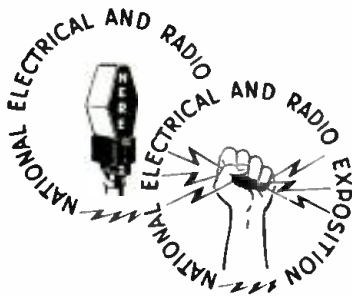

- The Modern Wonders of Electrical Science and Invention Unfold Before Your Eyes?
- The Modern Miracles of Radio and Electricity Demonstrated in Terms of "The Man in the Street"?
- The Mystery of the Ultra-Short Waves—the Cathode Rays—Electronic Super-Amplification—the electric Brain that thinks like a man.
- The Electric Eye that does such amazing things as The Servant of Man?
- A hundred and one inventions and developments brought forth by the genius of the Giants of Invention and Research.

The Radio Knife

The Electric Tongue

The Talking Book

How Science Locates Underground Treasure
The Ship's Eye that Sees Through the Fog
The New Electronic Musical Instruments

- The New Art of Electron Control from the World of Radio that is today revolutionizing our daily lives, science, industry, technology, chemistry, surgery, therapeutics, metallurgy, mining, music.

Would you like to see these amazing inventions and developments—see them and hear them explained?

Then Come and See Them Demonstrated

in the

Hall of Science

Under the Direction of Dr. Orestes H. Caldwell, Noted Authority in the field of Science and Radio, at the

National Electrical and Radio Exposition

GRAND CENTRAL PALACE
Lexington Avenue between 16th & 17th Street
NEW YORK CITY

General Admission 25c

A Review of Progress—all that electrical science and industry have to offer in the fields of Lighting, Heating, Refrigeration, Air Conditioning, Oil Burners and Domestic and Industrial Appliances.

**September
18th to 28th incl.**

Daily incl. Sunday
11 A.M. to 11 P.M.

Please Say That You Saw It in RADIO-CRAFT



METAL RADIO TUBES

An Editorial by HUGO GERNSBACK

RADIO vacuum tubes (triodes) started out originally as simple round glass bulbs containing three elements—filament, grid and plate. These first tubes, of the vintage of 1907, were produced by Dr. Lee DeForest. At that time there was no such thing as a base and socket; four wires simply were led through the glass envelope and were insulated by differently-colored fabric sleeves. That was the birth of the vacuum tube. Soon, tubes became a bit more finished and a metallic base was added. Later, during early attempts to standardize the tube this base, which really was nothing but a metallic sleeve cemented to the glass envelope, gave way to a composition "sleeve" or base. Meanwhile, the tube was becoming more complex.

In the original vacuum tube there was very little metal within the envelope, whereas in the modern, more complex tubes, containing as many as five grids, special plates, screen-grids, caps, etc., the weight of metal (which increased by leaps and bounds) is considerably greater than that of the glass envelope.

While the "glass" type of tube reached a very high standard of uniformity in production due to automatic machinery, radio engineers have always felt that the process could be still further improved upon by entirely doing away with the glass. While the breakage of glass tubes in transit was not an important factor, there still was considerable breakage due to handling. There was also a factor of microscopic cracks in the glass which often made the tubes useless after a short period of use. Finally, the glass tube was thought of as taking up too much space in the modern sets.

Several years ago, an English company started to manufacture wholly metallic tubes in which practically no glass was used except in connection with certain parts of the sealing (*Radio-Craft*, August 1933). Unfortunately these tubes were not properly engineered and they did not come into general use. The idea, however, had been watched very carefully by American engineers. They, in turn, improved upon the original English metallic tube and invented an entirely new sealing-off process which involved the use of small minute glass beads—the only form in which glass is used in the American type of "all-metal" tube.

The American tube it is believed has been better engineered, and a new welding process has been developed whereby the all-metal tube becomes a tremendously strong article which should not suffer from breakage, and which should last for a long while.

Many questions have arisen, not only in the radio trade, but among laymen as well, in connection with all-metal tubes, and it might be well here to state our viewpoint on some of the major questions.

Are Metal Tubes Here To Stay? IT IS OUR BELIEF THAT THE METAL TUBE IS HERE TO STAY. It is a major cycle in the advance of radio; and, while revolutionary in many respects, it reflects the trend of the machine age, mass production, and efficiency. The metal tube is here to stay because in time it will be possible to

manufacture these tubes by means of new machinery, invented specially in connection with these tubes, at much less cost to the ultimate consumer.

Are Metal Tubes Better Than Glass Tubes? When it comes to actual working, that is, radio performance, it is believed that the new metal tubes are not, at the present time, superior to glass tubes—but *they are not supposed to be!* Do not forget that metal tubes are in their infancy. It will take a little time before they prove themselves to be more efficient than glass tubes. That time, however, will rapidly arrive. In electrical efficiency metal tubes are now about on a par with glass tubes, but they have mechanical advantages not inherent in glass tubes.

Will Metal Tubes Last Longer Than Glass Tubes? In the very nature of their design, metal tubes will last longer than glass tubes. They will, therefore, be more economical than the older type.

These are the chief questions that have come up since the advent of metal tubes. There are, however, a number of other points of interest. The metal tube is the first one which tends to correct that ancient evil of the glass tube—i.e., to fit the tube quickly into its respective socket. I have consistently advocated this idea in my editorials in this magazine. In the November 1932 issue of *Radio-Craft* I stated as follows:

"Have you tried to replace a tube in a set these days—and who hasn't? Unless you are a magician or are equipped with X-ray eyes; or unless you have Einsteinian faculties that enable you to look around corners, it is next to impossible to put a tube in a socket these days.

"Eventually the tube and set manufacturers will get together again and do something about it, so you can place a tube in a socket without running a temperature, and without cursing tube and set manufacturers."

I am happy to say that, after several years, this objection has been overcome. The new metal tubes have a keying pin whereby it becomes, by contrast, a pleasure to put the tube in the socket.

The new metallic tubes take a great deal less room than the glass tubes, and some of the new tubes are so small that it becomes possible to build much more compact sets (for certain special purposes) than ever before.

A number of people still bring up the argument that you cannot see inside a metallic tube to determine whether it is functioning. This argument holds no water either, because you have only to touch the tube with your finger; if it is warm, it is functioning. You do not *have to see* whether or not the filament is glowing.

Remember that the metal tube is new. I have no doubt at all that endless advances will be made in the development of the metallic tube, just as tremendous advances were made in the design of the glass tube before it reached its present peak. Give the metal tube a chance and watch it grow. *Three years from now we will wonder why we ever bothered with glass tubes that had to be handled with kid gloves, and which future radio historians will wonder at on account of their many shortcomings!*

THE RADIO MONTH



The French notice regarding television.

TELEVISION IN FRANCE

THE experiments with television in England and Germany have aroused such a furore in Europe that the authorities in France became fearful lest their efforts along the same lines might be misinterpreted. (See the preceding, TELEVISION NUMBER of *Radio-Craft*.)

Accordingly, last month, French radio magazines contained the following announcement:

TELEVISION

Notice to the Public

With the object of helping the public avoid great disappointments the Professional Syndicate of Radio-Electric Industry (Syndicat Professionnel des Industries Radio-Électriques) feels it its duty to announce that the transmissions of views now being undertaken at the Ministry of Telegraphy, Telephony and Postal Service are no more than experiments undertaken to aid in the research into television problems.

There will be a long period of severe labor before any honest manufacturer will be able to put on the market a television apparatus which will be at all satisfactory to the purchaser.

The Professional Syndicate of Radio-electric Industry desires to place the public on its guard against unscrupulous manufacturers who, with the aid of announcements of progress from the research work at the ministry are deceiving the public by announcing that the receivers they are selling are able, either immediately or after modification, of receiving views.

Such statements are lies

In short it may be stated that:

Practical television is not yet in existence.

The date when it will come about cannot be stated.

Television will ultimately be a complement of radio, but it will never replace it, and it will demand a special apparatus which will not do away with existing radio sets, but will be auxiliary to them.

Therefore in buying, don't wait any longer for a general television-radio receiver.

Professional Syndicate of Radio-Electric Industries.

"SPOT" BROADCAST FROM VESUVIUS!

VESUVIUS, that age old "fiery mount" which has endangered the lives of those who braved its slopes since the days of Pompeii made its "radio debut" to American radio listeners last month.

Two engineers of the NBC, accompanied by officials of the Italian Broadcasting Company climbed to the rim of Vesuvius to broadcast its rumblings to the United States. Within two hours after they had completed their program, the spot on which they stood was scattered all over the Bay of Naples!

The eruption, the most devastating in recent years, came so soon after the broadcast that the NBC microphones were still in the crater. One was blown to pieces and the stream of molten lava ate up the wires as well as other equipment.

It is interesting to point out that broadcast engineers covering "spot" and news events are fast earning the same reputation as newspaper photographers who will go to any extremes to get a picture.

Radio has played an important role in the vicinity of Vesuvius in recent upheavals as a means of quieting the people in the vicinity as well as warning those in the danger zone to move to safety. Entertainers sent to the mountain slope broadcast to prevent panic.

These artists broadcast to calm the people.

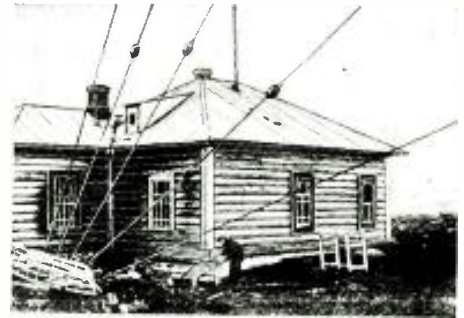

The station from which the Arctic radio newspaper is transmitted.

ARCTIC RADIO NEWSPAPER

THE ever-widening circle of applications to which radio can now be put includes a daily radio newspaper to inhabitants within the arctic circle, according to a report received by *Radio-Craft*, last month.

The obvious impossibility of distributing a daily paper to the wide-spread inhabitants of the north country is surmounted by sending the news via the radio station on the Dickson-Iland, belonging to the U.S.S.R. News of world happenings as well as items of interest to these polar dwellers are broadcast daily, according to the report.

And no doubt a little propoganda about the Soviet States is sandwiched between the news items, according to accepted European practice!

HOUSE RIPS OUT P.A. SYSTEM!

ALL because Speaker Byrnes' gavel started loud reverberations when he pounded his desk in the House of Representatives the trial P.A. system, which was installed there last month, was taken out after only one hectic day.

This installation, which would be of great assistance to those sitting in the galleries and the rear of the "floor" caused much excitement for the short time it was tried.

The presence of the five microphones strategically placed through the chamber was a surprise to members and newspaper men. As the session began, there was considerable amusement at side remarks of members near the mikes. They spoke without being aware that their words were being carried through the amplifiers.

The excitement created by this experiment recalls the row stirred up in the House when Senator Carter Glass refused to use the first dial telephone! But the wheels of Progress do not stop!

IN REVIEW

Radio is now such a vast and diversified art it becomes necessary to make a general survey of important monthly developments. RADIO-CRAFT analyzes these developments and presents a review of those items which interest all.

"D-LAYER"— THE NEW RADIO ROOF

THE first experimental proof of the existence of the "D-layer" was reported last month by Dr. M. P. Syam of the University College of Science, Calcutta, India. The "D-layer" which was first suggested in 1930 by Professors E. V. Appleton and J. A. Radcliffe of England, absorbs long radio waves and is penetrated by waves below a definite length.

Unlike the E and F ionized layers which reflect radio waves, permitting long distance communication, the reflection of waves by the D layer appears to be rare.

Radio experts at the Bureau of Standards regard the proof of the existence of the D layer as being of wide interest because of the possibility that this layer may explain the occasional poor transmission of ordinary broadcast waves during the daytime.

Recent experiments such as this one are doing much toward furthering radio theory!

MYSTERY RAY "SEES" 50 MILES!

A NEW "mystery ray" of the U.S. Signal Corps which is said to be able to detect the presence of a ship or plane more than 50 miles off the coast was demonstrated last month, amid elaborate plans for maintaining secrecy.

While no definite information could be obtained regarding the nature of this new ray, it is assumed that it is somewhat similar to the demonstration made in Berlin some days before, using radio waves of 3 to 18 centimeters which cast a sharp beam out as far as the eye can see (about 50 miles from a height) which is reflected by any metallic object it comes in contact with. The reflected beam is then received on the ground and the location of the object determined by triangulation.

Equipment used in the Berlin ray demonstration. The dipole at the left is the beam aerial.

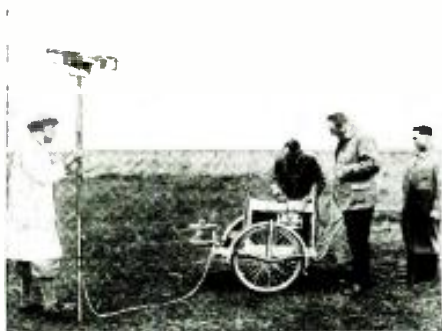

The plane shown above took off, flew and landed without any pilot on board! Radio controlled it.

RADIO PLANE FLIES WITHOUT PILOT!

THE high state of development of radio "dynamics" or the remote control of mechanical devices was proven last month in England.

A small plane took off, flew at over 100 miles-per-hour and landed safely without a soul on board! During its flight and maneuvering the plane was controlled by three operators with a small portable radio transmitter at the airport from which the plane took off.

The possibilities of this experiment both for military and commercial use are gigantic—imagine for instance, a fleet of these planes, controlled by a dirigible or a ship many miles away, attacking a city such as New York! Or, on the other hand, imagine a line of such planes carrying mail, fast freight or even passengers, and controlled entirely from the airports from which the planes originate and at which they terminate. Or, imagine a plane designed for long distance flying (they have been made to cover 7,500 miles without refueling) crossing the Atlantic or Pacific Ocean!

INTER-CAR RADIO FOR G-MEN

FURTHER information about the radio activities of the Federal Bureau of investigation has become available within the past month.

Several months ago, we announced the plans for a secret national network of radio stations for the G-men. Now, we learn that their cars are equipped with transceivers, permitting two-way communication between cars and between the nearest headquarters and any of the cars of the fleet.

And while on the subject of police radio, Captain Donald S. Leonard of the Michigan State Police reported to a radio committee on police radio that state and municipal police systems are breaking the law by communicating with each other. Police radio transmitters are licensed to broadcast only to mobile units.

RADIO TAXIS IN PARIS

THE taxis equipped with radio sets which made their appearance last month on the streets of Paris have met with great success. At present there are 5,000 of these taxis running, and according to reports, many more are being equipped to supply radio entertainment, en route.

A tax of 100 francs per year is paid by the taxi companies to the French government for each radio set in a cab.

Another interesting news item, from another part of the globe concerning auto radio, also made its appearance last month. It seems that the seasonal decline in the sale of radio receivers which occurs every summer is being practically counterbalanced this year by the tremendous increase in car radio sales, according to the Canadian Commerce Department. The sales of auto sets in April and May of this year showed a gain of over 25 per cent over March.

Coincident with this increase in sales, a generally lower trend in prices is reported, as indicated by the fact that in March the average list price was \$70.40 while in May the average price was slightly less than \$62.00.

THE METAL TUBES IN CHINA

OUR report of the altercation between G.E. and Philco regarding the new metal tubes on page 6 of the July issue has aroused not only national but international interest, as illustrated by the Chinese translation of our comment which appeared last month in *China Radio*.

The humor of this situation is not at once apparent, but in the humble opinion of the Editor, there is some very subtle humor in a Chinese explanation of an American "cross-word puzzle"!

This is not a laundry ticket—but an item in Chinese reprinted from "Radio-Craft!"

中國無線電 China Radio

真空管之競爭

G. E. 與 PHILCO

此項之爭論，係關於真空管之競爭。G.E. 與 PHILCO 兩公司，均為世界著名之製造商。其產品之優劣，實為電氣工程師所關注。然此項競爭，實為市場之進步，亦為消費者之利益。故我們應以客觀之態度，來評定其優劣。...

(一) PHILCO 之廣告

PHILCO 公司之廣告，係在 New York Times 報上發表。其內容如下：...

RADIO PICTORIAL

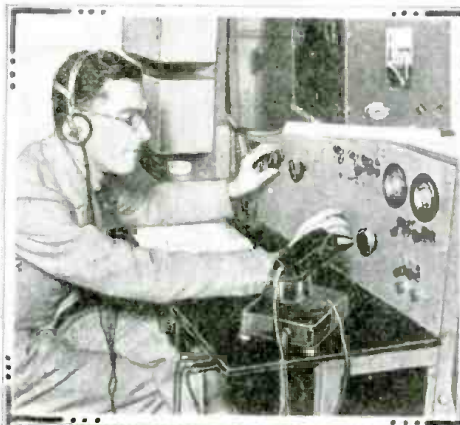

TELEVISION PROGRESS IN ENGLAND IS HERE VISUALIZED. Left, we see the operator in the control room regulating the "see-performances." Below, this is not a set-up in a movie studio, but preparations for a boxing scene in the Crystal Palace Studios. Note that the ring is quite small. At right, transmission of a horse jumping. The equipment for this latter transmission is housed in a mobile van, and can be sent to the scene of the event to be viewed.

(Radio Press Service)

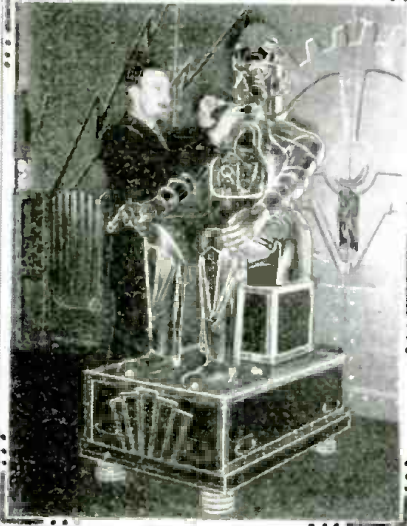
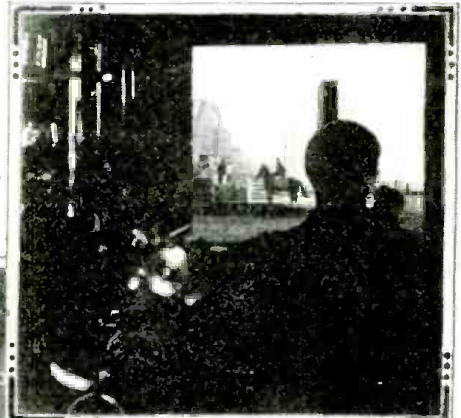

ROBOT, "ALPHA," WHO EMITTED STRANGE NOISES AT THE SAN DIEGO FAIR! An investigating technician was knocked "cold" while seeking the trouble. Radio experts found the fault lay with the Fair's radio station. Prof. May is adjusting his robot.

(International News Photo)

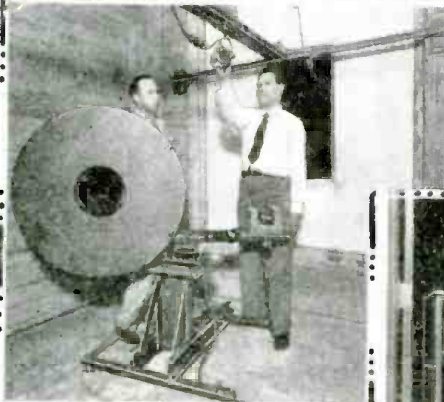
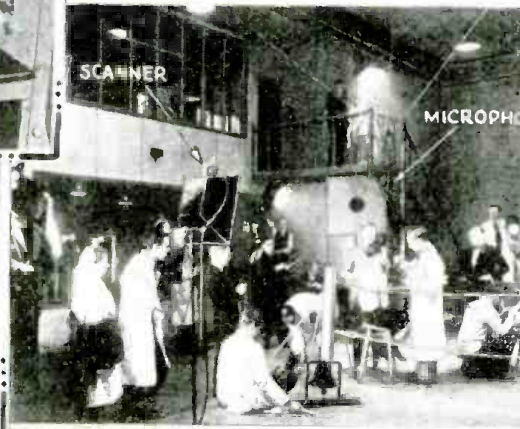

← LEFT, A REVOLVING SPEAKER TO AID TONE UNIFORMITY. Developed by Bureau of Standards.

← Kneeling before sound transmission equipment is V. Chrisler, while W. Snyder reads the sound meter of apparatus for measuring sound transmission. Measurements are taken (at a number of points on each side of the panel) at 9 points in the frequency band of 128 to 4,096 cycles per second.

(Harris & Ewing)

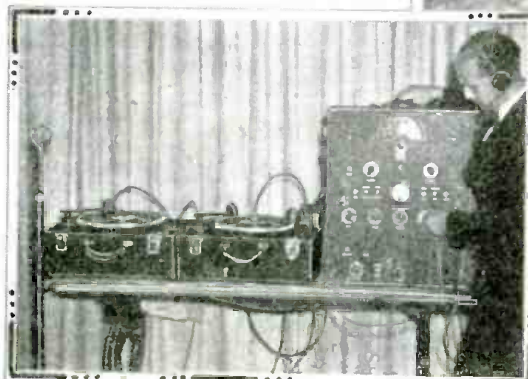

APPARATUS USED BY "G" MEN FOR WIRE-TAPPING! The unit shown was built by Mr. A. W. Nieman (shown) for officials of Colombia, S. A. It contains an all-wave radio set, amplifier, mixer, tone control, and arrangements for recording or reproducing any of the sounds picked up. These outfits have been used in many prominent cases.

(A. N. Mirzoeff Photo)



ABOVE, A PARACHUTE RADIO. We see A. Y. Vishnevski, constructor of the tiny radio used for communication with parachutists in mid-air, showing parachute jumper P. I. Klimova the novel receiver. More than 10,000 recently attended an exhibition of jumping near Moscow!

(Sovfoto)

CHECK YOUR WATCH, SIR?

You place it on the microphone box at the left. An accurate tuning fork is used as a frequency standard to control the driving motor. The action of the watch is recorded instantaneously as a printed record.

(RCA Victor Photo)

"INSTANTANEOUS" TEST OF WATCH





The interior of the Safety Car, showing the radio control panel, with Sgt. Conroy operating. (Address Radio-Craft for name of manufacturer.)

TWO-WAY POLICE RADIO INTRODUCES "SAFETY CAR"
 This new system works on a wavelength of $9\frac{1}{2}$ meters. All 35 patrol cars are radio-equipped as is the "Voice of Safety" car shown here. Right, Sgt. Sullivan in Jersey City, N. J., Police Headquarters.

(Photos by Halbran)



Sgt. Conroy using the portable microphone. All equipment, except the control panel, is located under the rear deck. Besides the main operating room at Headquarters, two receivers at remote points are used to provide reliable communication.



MESH ANTENNA IN ROOF OF CAR FOR RECEPTION



View above shows "safety" speaker, and locations of the two separate antennas carried by all 36 cars. Car-to-car and car-to-headquarters 2-way communication is maintained.



A general view, above, of the transmitting equipment, with Detective Conroy at the transmitter, while Sgt. Sullivan talks to the Safety Car. Right, a crowd listening to a talk on safety being picked up on the car's receiver and reproduced through the speaker on the roof. The speaker can be used either in this way, or it may be operated by the microphone and amplifier located in the car itself. Chief of police Daniel Casey claims remarkable results in the safety campaign, although the system has only been in operation a short time. The rod visible on the car is the transmitting antenna. A mesh antenna in the roof is used for reception. The patrol cars are all similarly equipped except that they do not have the speaker; nor are they painted white.



The control box used at the Headquarters station which puts the 100 W. transmitter into action. When the large button is up, the receiver is automatically connected in.

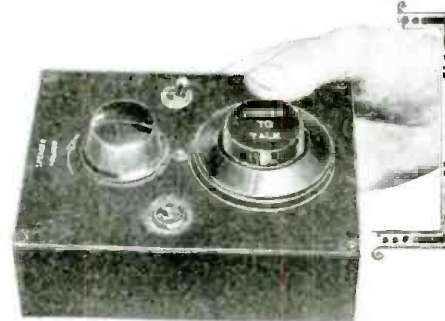

NEW DESIGN IN 20W. P.A. AND RADIO SYSTEM Used on "Garden of Nations' Roof" at Rockefeller Center, New York, it includes radio and phonograph facilities. Portable speakers are used at 20 strategic points.



Handsome mahogany cabinets house and conceal this technical apparatus. A microphone may be connected at will. The "works" are also housed in mahogany cabinets as shown at left. The tuning dial and monitor speaker at the bottom of the cabinet are clearly seen. The rear view shows the receiver and amplifier used.

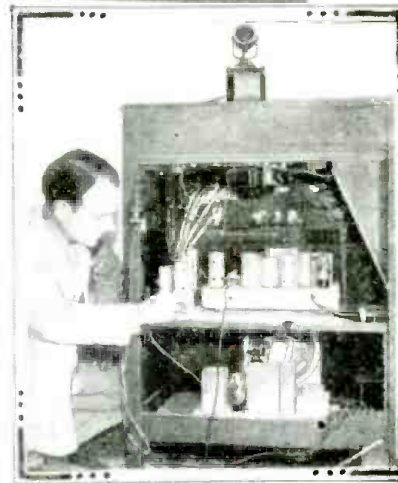

(Halbran Photos)

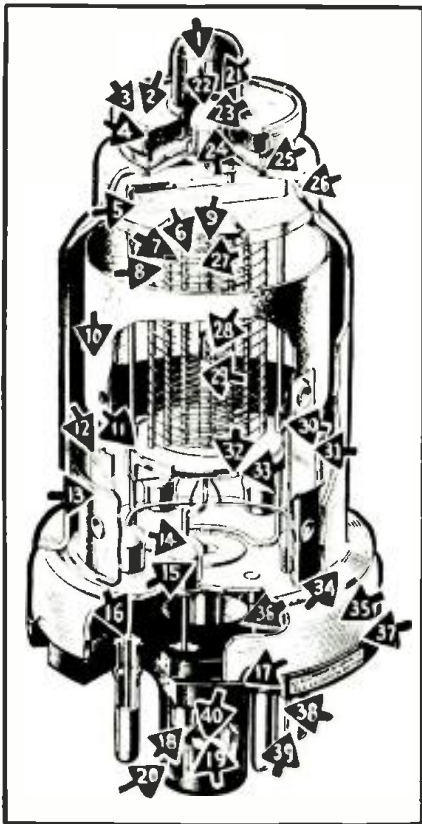

Fig. 1. Table I lists the above details.

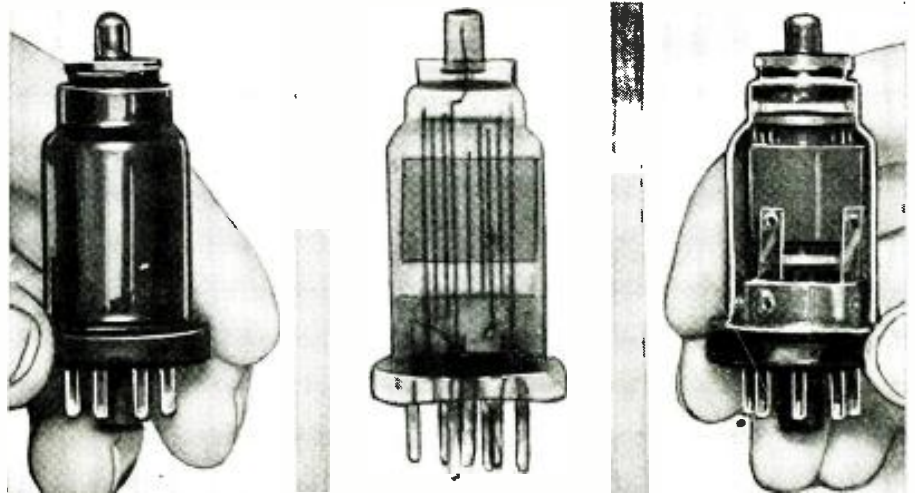

Fig. A. Left, metal-tube exterior; center, "X-ray eye" view; right, cross-section. (G.F.)

AN INSIDE STORY ABOUT METAL TUBES

Interesting details concerning the all-metal tube; also, recently-introduced, associated types are described.

R. D. WASHBURNE

METAL tubes—being more compact, inherently strong in structure and having many manufacturing advantages over glass tubes—fulfill an urgent need in the field of applied electronics.

As the artist has expertly illustrated, Fig. B., the glass tube design that has held sway for the last 28 years at last has succumbed to the modern demand for "quantiquality" (a word coined by Sachs which aptly typifies the modern demand for greater production and closer tolerances)!

THE GLASS PROTOTYPE

The case against glass tubes is a strong one, but only a few important points will be mentioned.

That there is little difference between the elements inside the glass and the metal envelopes is evident by ref-

erence to Fig. F. This view shows that a great amount of material required in order to secure rigidity within the necessarily large glass bulb, is not required in a metal tube.

It is necessary to coat the glass bulb with a graphite preparation in order to prevent the collection of potential charges on the bulbs, especially at the higher radio frequencies. The metal envelope eliminates this fault, permitting perfectly satisfactory operation right on down to below 5 meters! (See the article, "An 18 Metal Tube All-Wave Superhet," in this issue.)

The metal tube structural requirements previously mentioned, and some of those hinted at, will be evident by reference to Fig. 1, which illustrates a typical screen-grid tube; a description is given in Table I.

(Continued on page 231)

TABLE I

(1) Solder	(23) Glass Bead Seal
(2) Cap Insulator	(24) Fernico Eyelet
(3) Rolled Lock	(25) Brazed Weld
(4) Cap Support	(26) Vacuum - Tight Steel Shell
(5) Grid Lead Shield	(27) Cathode
(6) Control-Grid	(28) Helical Heater
(7) Screen-Grid	(29) Cathode Coating
(8) Suppressor-Grid	(30) Plate Insulating Support
(9) Insulating Spacer	(31) Plate Lead Connection
(10) Plate	(32) Insulating Spacer
(11) Mount Support	(33) Spacer Shield
(12) Support Collar	(34) Shell - to - Header Seal Weld
(13) Getter Tab	(35) Header
(14) Glass Bead Seal	(36) Shell Connection
(15) Fernico Eyelet	(37) Octal Base
(16) Lead Wire	(38) Base Pin
(17) Crimped Lock	(39) Solder
(18) Aligning Key	(40) Exhaust Tube
(19) Pinched Seal	
(20) Aligning Plug	
(21) Grid-Cap	
(22) Grid Lead Wire	

(Additional construction details appeared in the article, "Now—Metal Tubes," in the June, 1935 issue of Radio-Craft.)

Fig. B. GOING—going— . . .



Fig. C. "Metal-spray" tube.



Fig. D. Metal-glass tube.



Fig. E. Glass-"metal" tube.



TESTING METAL TUBES ON A "BEGINNERS' BREADBOARD"

Beginners find it difficult to wire up circuits from a schematic diagram, preferring to follow a "pictorial layout"; experienced technicians, to save time, resort to "haywire" hook-ups. The "breadboard" set-up solves these problems of tyro and expert, equally well.

N. H. LESSEM

EVERY TIME a new development in radio is announced, almost immediately there is a feverish rush to apply it to the thousands of circuits which have appeared time and again in various radio periodicals. Nor does the rush subside then, for every radio man and experimenter has a few pet circuits of his own securely tucked away in the back of his mind—circuits which, peculiarly enough, seem more and more to fit in with these new ideas as they appear. And, to add to the excitement, new ideas in radio are not any too scarce.

The latest rush has been started by the appearance of the new series of all-metal tubes. Everyone is working madly to test these new tubes in various circuits.

To facilitate matters we introduce the Beginners' Breadboard, which is a "clip set" designed to expedite the building and testing of these various circuits. This clip-set idea is not a new one; it was first introduced by Hugo Gernsback 'way back in the days of 1924-'25—the so-called "era of reflex circuits." (This device enabled hundreds of experimenters to build and try the many different types of reflex circuits in a comparatively short time, whereas, otherwise, a period of months would have been required to thoroughly check each individual circuit.)

For many years the clip set was a popular piece of apparatus in every experimenter's laboratory. Gradually, however, it became a commonplace thing and was not mentioned very often in radio magazines.

Recently, the clip set, in a modified form, broke into print once more, in the August and September, 1935 issues of *Short Wave Craft*. Now, we bring it to you to facilitate testing of the new series of all-metal tubes.

The clip set is a very flexible, practical and convenient device containing practically all foundation units for constructing or checking 1-, 2- and 3-tube circuits built up around the all-metal tubes. It provides to its owner the option of using any of the 10 different initial types of all-metal tubes, without changing any sockets—since these tubes use a universal, 8-prong keyed sockets; employing transformer, or resistance-capacity coupling, or both; using potentiometer, or variable condenser control of regeneration; and, of constructing battery, A.C., or A.C.-D.C. circuits. All this can be done
(Continued on page 239)

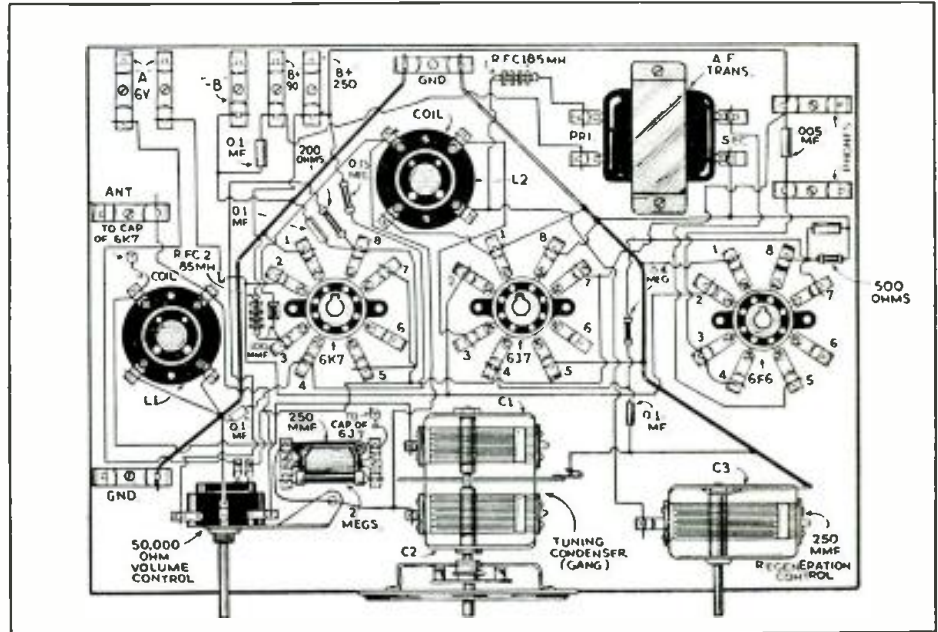

Fig. A. The positions of the parts of the "clip set" are clearly evident.

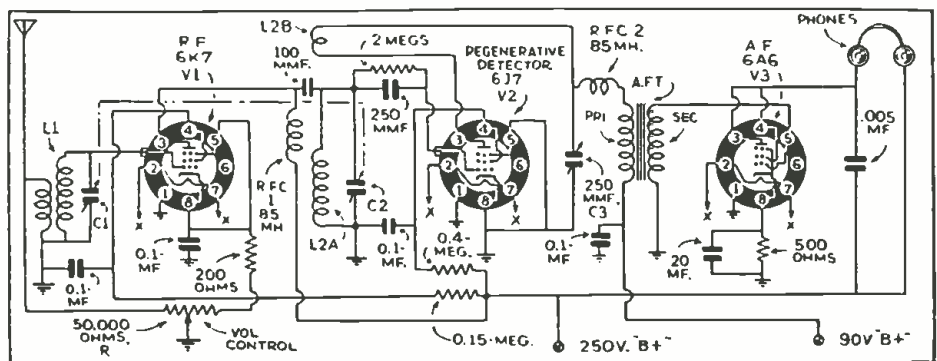
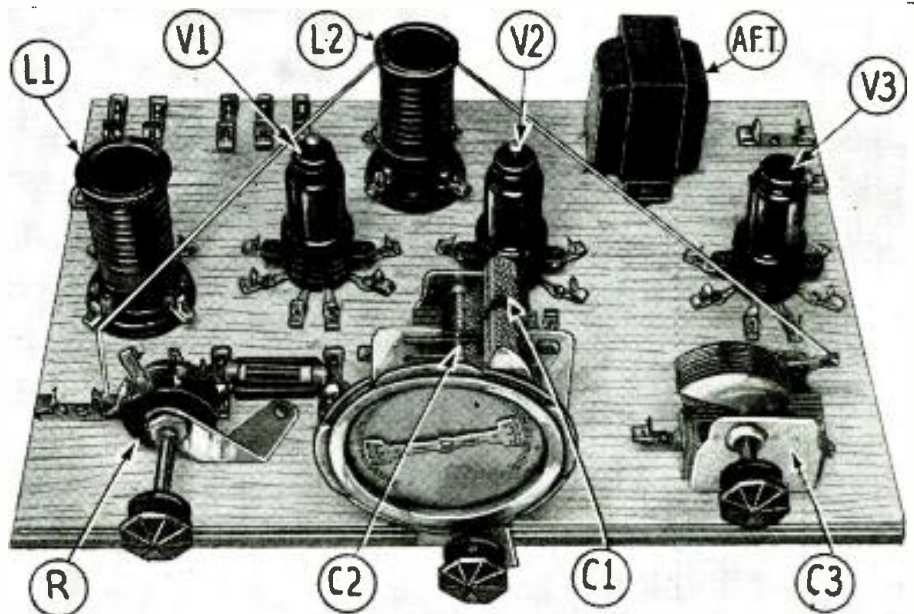
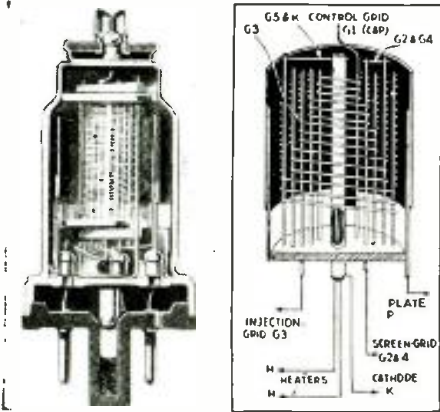

Fig. 1, above. The schematic circuit of the typical 3-tube set described.
Fig. 2, below. The picture layout of the same set (shown above).





NEW 6L7 PENTAGRID "MIXER-AMPLIFIER" METAL TUBE

"Injection grid" and "mixer-amplifier" are new terms introduced to radio in the description of this new metal tube.

C. W. PALMER

THE PENTAGRID (5-grid) tube, that first earned fame as a combined "oscillator-mixer" (or, "first-detector"), in a new design will soon annex laurels as a combined "mixer-amplifier"!

When the 2A7 and 6A7 pentagrid frequency converter tubes were first introduced in June 1933, they represented a marked advance over previous methods of frequency conversion for superheterodyne receivers. In fact, so enthusiastic were radio engineers that claims were made that these tubes would overcome all the ills previously encountered.

And for a time these claims proved to be true.

But, the introduction of commercial all-wave receivers on the market brought forward new problems which showed the 2A7 and 6A7 tubes to be deficient, especially on the high-frequency end of the short-wave spectrum. The oscillator efficiency which held up nicely on lower frequencies was found to be inadequate at the low frequency ends of the high-frequency bands! So, engineers sought means to increase the operating efficiency of the tubes on these frequencies.

Several circuits were devised, in which a triode tube was used either to boost the oscillator output or to entirely replace the oscillator section of the tube, "injecting" a local oscillation from a separate oscillator tube into the converter by means of the "virtual cathode" or as it is commonly called, the oscillator-section grid.

This system permitted better efficiency but another difficulty entered the picture in the form of coupling between the control-grid (grid No. 4) and the injection-grid. While this coupling is small and is not noticeable in the tube's operation on the broadcast band and the low-frequency end of the short-

wave spectrum, it was a source of annoyance to set designers who made sets running down to 10 meters, or so.

THE 6L7 PENTAGRID "MIXER-AMPLIFIER"

With the introduction of the new line of metal tubes, tube engineers have taken advantage of the opportunity to bring out a new tube which is particularly designed to eliminate the difficulties described above. This new tube is to be known as the 6L7 and is a pentagrid tube of a type called a pentagrid mixer-amplifier designed with two separate control-grids shielded from each other.

This design permits each control-grid to act independently on the electron stream (from cathode to plate). Thus the tube can be used as a mixer in superheterodyne circuits having a separate oscillator stage, as well as in other applications where dual control is desirable in a single stage.

The circuit at Fig. 1A shows the elements of the tube in their respective order. First, there is the cathode, surrounded by G1 which is the signal control-grid; next is G2, the screen-grid; then G3, which is the second control-grid or "injection-grid" where the oscillator voltage is applied to the mixer; next the second screen-grid tied to G2; then suppressor grid G5; and finally the plate surrounds the entire group.

The circuit, Fig. 1A, shows the first method of using the 6L7 as a mixer-amplifier. The tube is connected as a straight pentode, between the preselector and the first I.F. transformer. The oscillator, which may be a 6C5 metal tube is connected in the usual manner, and the injection-grid of the 6L7 is connected directly to the grid of this oscillator, thus biasing the grid at the

same potential as the oscillator grid. This is the preferable method of tying the oscillator to the mixer-amplifier, though there is a second method which can be used. The advantage of the method described is that the gain of the converter is practically independent of the oscillator voltage, over quite a wide range. In the second method, shown in Fig. 1B, the injection-grid is separately biased, and is coupled to the oscillator through a condenser.

The advantage of this tube over the use of an ordinary pentode as mixer tube, using the suppressor-grid as the "injection-grid" (a method resorted to by several manufacturers) is the fact that although grids 1 and 3 both control the electron stream of the tube, they are effectively shielded from each other by the screen-grid, G2. Thus the ills of "circuit locking," ineffective injection control, and inter-electrode capacity between the input and the injector circuits are avoided.

(Continued on page 239)

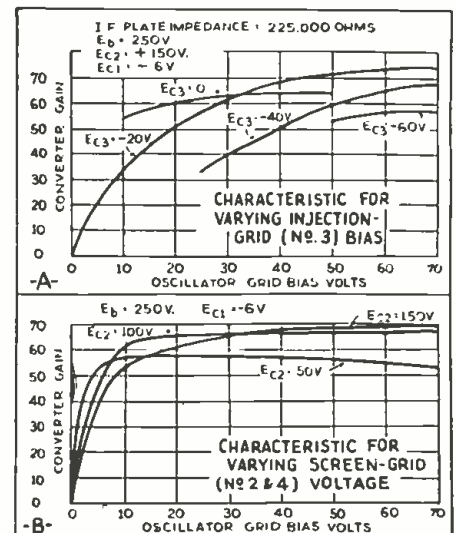

Fig. 2, below. The 6L7 as an A.V.C.-controlled R.F. or I.F. pentode amplifier.

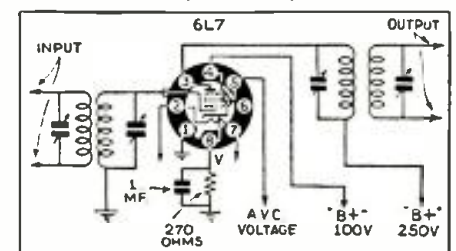
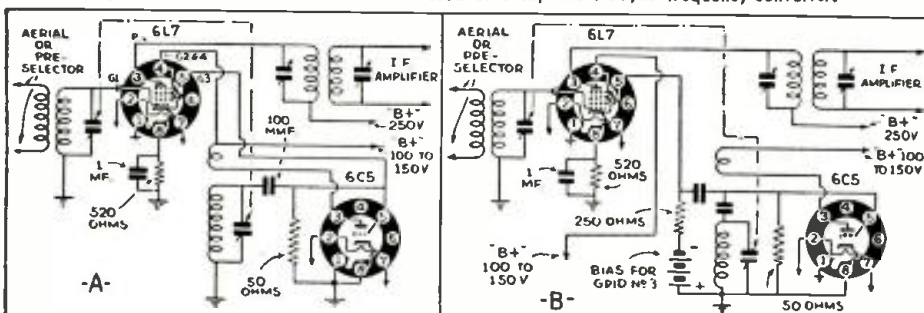

Fig. 1. Two circuits for the 6L7 when used as a superheterodyne frequency-converter.



MAKING THE LAZYSMAN "4" RECEIVER

Pre-set padding condensers are the "heart" of this delight to the "laziest man in the World"

N. H. LESSEM

THE RECEIVER to be described is quite conventional in design. It consists of a stage of tuned R.F., a detector, and one stage of A.F. amplification; a half-wave rectifier delivers "B" power.

As certain types of the metal tubes are not suitable for combined A.C.-D.C. operation, the new "metal-glass" tubes were used. These tubes use the same new 8-prong octal base as the all-metal tubes. The characteristics of the 6J7MG ("MG"—metal-glass) and the 6K7MG are similar to the 6J7 and 6K7 tubes in the all-metal series. The 43MG and 25Z5MG are similar in characteristics to the 43 and 25Z5 in the older-type glass tubes. (The physical construction of these tubes is described elsewhere in this issue.)

The station pre-selector arrangement is obtained by the use of an improved type of mica compression condenser. Suitable condensers are connected across the grid-circuit inductances of the R.F. and detector tube by means of double-pole, single-throw switches. By using the various condensers that are shown in the List of Parts, your favorite stations may be tuned in accurately by careful padding.

It is important to mount these 12 padding condensers as shown in the accompanying photograph. Due to the construction of these condensers misalignment is practically impossible. It is imperative that all grid leads be kept as short as possible and properly shielded wire must be used throughout in order to prevent circuit oscillation.

When using the pre-selector switches the center switch, shown as the all-station switch, should be snapped to the "off" position and then the individual switches for the desired station should be thrown on. When changing to another station the switch that is in the "on" position should be switched off before selecting another station. Otherwise the receiver will in all probability be thrown completely out of the broadcast band.

If conventional tuning is desired this may be obtained by snapping the center switch shown in the diagram as the all-stations switch to the "on" position. Rotating the tuning dial located on the right and side of the receiver brings in the stations in the usual manner. When using the tuning dial in this manner the station selector switches should be in the "off" position.

In conclusion a noticeable improvement over the glass-type tubes was very noticeable in that the hum level was

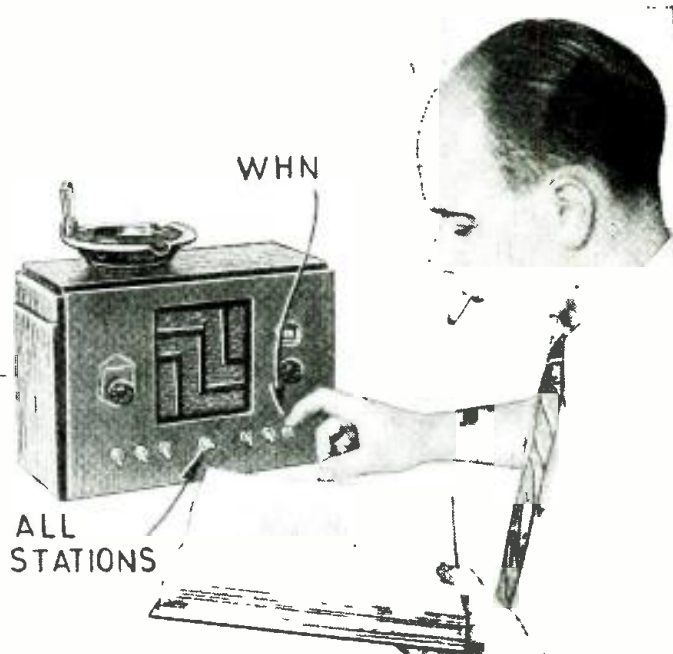

Fig. A. The snap switches tune-in the locals.

much lower and the output, considering that a single tube was used, was remarkably good.

As indicated in Fig. C, the pre-tuning padders are mounted by soldering to heavy, grounded busbar. (See Fig. 1) (The "hot" terminals for each pair of these condensers are located in the center of the respective mounting plate.)

Note: this set was not designed to establish world records for distance, selectivity or tone quality but was built solely to meet the demand for a radio set which would eliminate the annoyance of "fiddling around" for stations. The Lazyman "4" provides *instantly selected and accurately tuned* radio programs. (Continued on page 248)

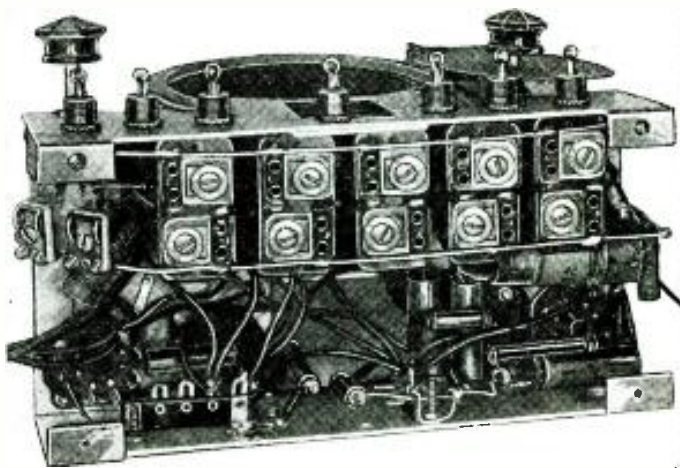

Fig. C. This view shows the pre-tuning padders, supported by the bus wiring.

Fig. 1. The pre-set padders may be seen in this circuit. Switch Sw.7 provides "normal" tuning.

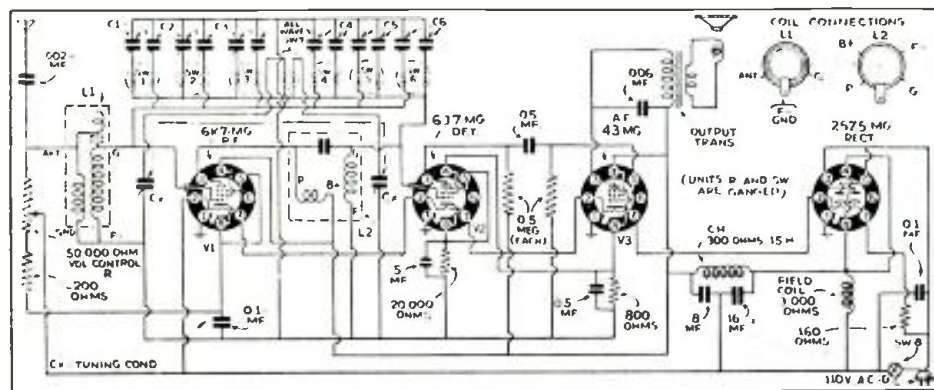
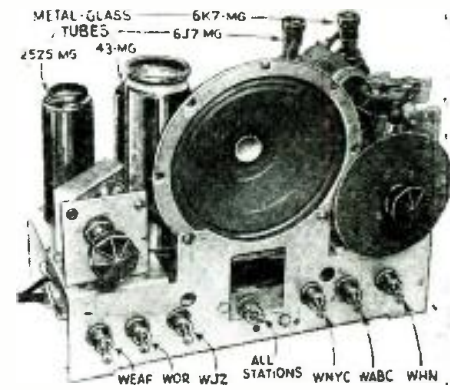

Fig. B. Here is the chassis removed from cabinet.



A METAL-TUBE ALL-WAVE TUNER

This adjustable-fidelity all-wave tuner is readily adaptable to existing receivers, or to the high-fidelity A.F. amplifier described on the following page.

H. R. WILLIAMS

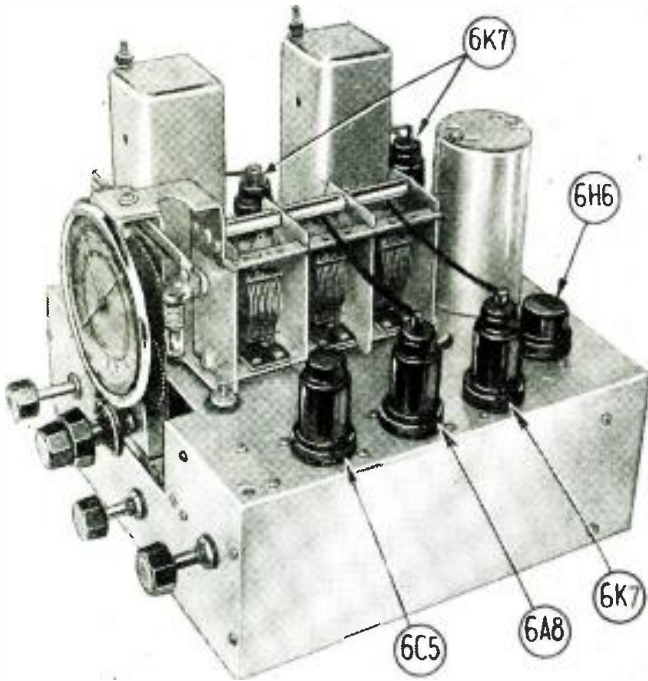

A SUPERHETERODYNE circuit is employed in this metal-tube tuner unit using a 6K7 as an R.F. amplifier working into a type 6A8 metal tube.

The 6A8 is used in a novel manner which results in a higher than normal conversion gain; the signal is fed into the control-grid, the oscillator-grid element has impressed upon it a small positive voltage. The oscillator plate and screen-grid are connected together. The plate is connected, in conventional manner, to the I.F. amplifier coil which is of the "high-fidelity" type. A separate metal tube, type 6C5, serves as an oscillator. Two stages of I.F. amplification incorporate the new metal-type 6K7 tubes. The first two I.F. amplifier coils are of the variable-coupling type now becoming so popular in the maintenance of high-fidelity performance. A final stage of fixed coupled I.F. amplification is employed. A double diode is used as a second-detector and A.V.C. tube.

Covering a tuning range of 12 to 575 meters (or to 2,000 meters, if desired,) the tuner unit is completely self-contained and embodies all the latest technical advantages of modern radio receiver design. When the tuner is completed, following the circuit and layout shown in Figs. 1 and A, it is ready for installation merely requiring disconnecting the present R.F. system of the receiver, and making five simple connections. The tuner unit shown contains its own filament transformer, volume control and power

switch, selectivity or noise suppression control, range switch control, and main station selector control, making a total of four knobs. The range switch incorporated is of heavy mechanical construction assuring positive contact on all bands.

For obtaining a constant program enjoyment, the variable-coupled high-fidelity I.F. coil system is essential, as it enables the listener to adjust the degree of selectivity to his particular needs. Continuous variations of the mutual inductance between primary and secondary of the I.F. amplifiers are obtained without affecting circuit constants. The approximate range of variation is from one-third critical coupling to over three times critical coupling.

The full-vision airplane-type dial used is of the planetary drive type, making a very positive vernier action. Also incorporated in the dial, which greatly facilitates short-wave tuning, is a red pointer which has approximately a 35 to 1 ratio movement with regard (Continued on page 240)

Fig. A. The positions of the parts used in the tuner are clearly seen in this and the top chassis view, above. The long rod at the left controls the I.F. coupling which is the fidelity control. The center rod is the wave-change control.

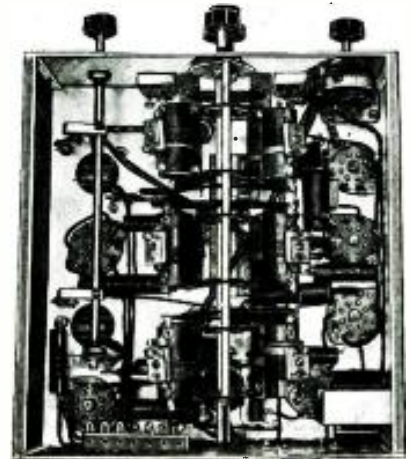
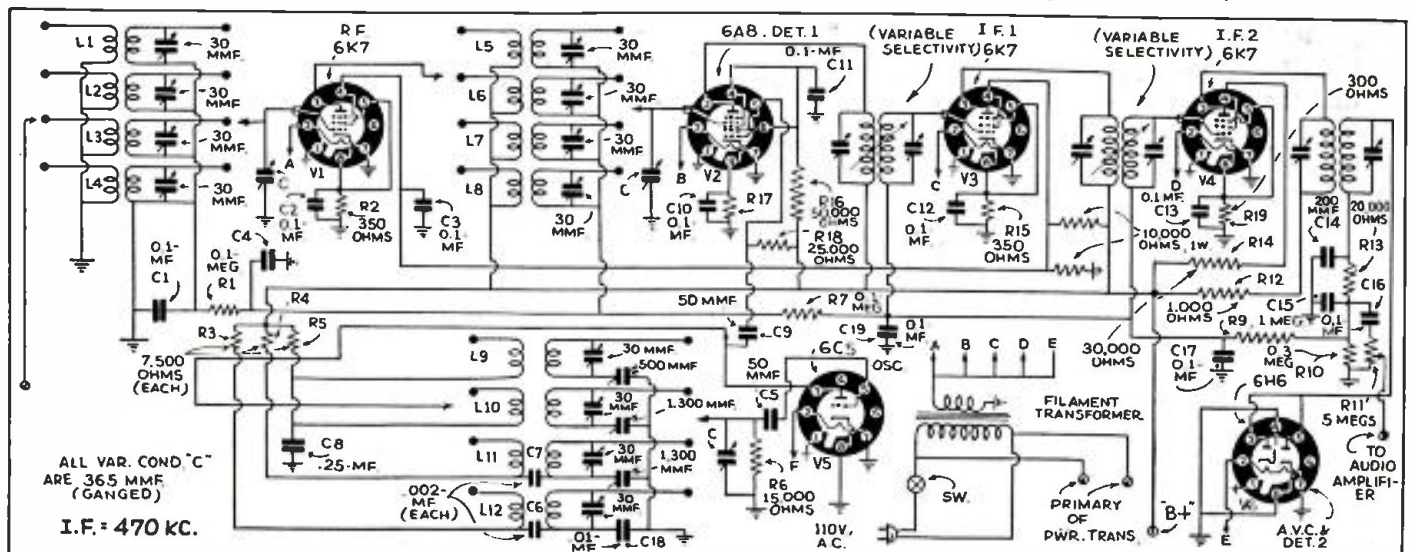

Fig. 1. The circuit of the tuner unit, illustrating the wave changing scheme and the method of obtaining variable selectivity I.F. action.



METAL TUBES IN A HIGH-FIDELITY AMPLIFIER

This 40 (or 20) W. amplifier is readily adaptable to the variable-fidelity tuner on page 206, opposite. Also suitable for P.A. work. J. B. CARTER

TO THOSE of us who have watched the progress of radio from its inception, the forward movement of the industry to produce at a reasonable cost, practical high-fidelity amplifiers has proven a most difficult feat. The recent new metal tubes however, have removed some of the most stubborn difficulties in the way of producing an A.F. amplifier with high-quality output, adequate for either a P.A. system or the audio output system of a fine radio set.

These difficulties all boil down to four: (1), gain; (2), hum; (3), fidelity; and (4), power-capacity. It has been unfortunate that most of our tubes with fairly high gain were not of the separate-cathode type, so that they tended to introduce hum, or else they failed to provide enough output to swing the grids of a final push-pull output stage wide enough. The metal tubes provide everything needed.

The general details of the amplifier circuit are standard. However, there are a number of features which are new and of interest. After careful consideration of all the metal tubes available, the following tubes were finally chosen as being the cream of the crop and also the most suitable for this type of amplifier. One 6J7, two 6C5s, two or four 6F6s, and three 5Z4 rectifying tubes.

The amplifier, Figs. A and 1, consists of three stages of transformer coupled amplification. The output stage uses four 6F6 tubes connected in a push-pull parallel arrangement that will deliver an output of 40 W. with only 5 per cent harmonic distortion present. For those who do not require this amount of power, two of the 6F6 tubes may be omitted, thus making the output stage straight push-pull. This will provide an output of 20 W. The only difference

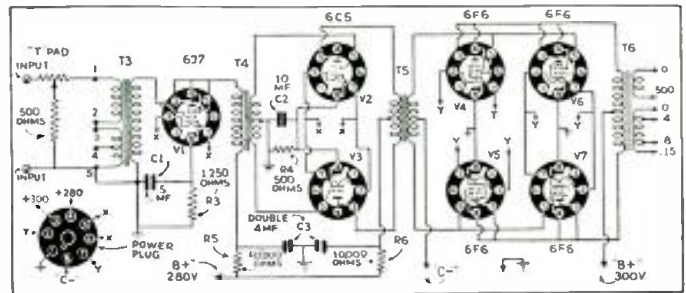
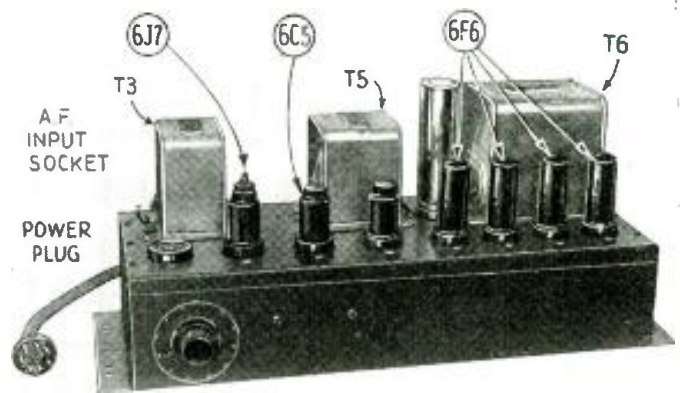

Fig. A, top; Fig. 1, above—the amplifier.

between the 40 and 20 W. amplifier are the power and the output transformers.

As noted in Fig. 1, the 6F6 tubes are connected as triodes in class A prime. This provides high A.F. power and low distortion. The static plate current is only 20 ma. per tube, but when it is driven, it increases to almost 55 ma. This is a factor in the economical side of class A prime operation. It means that the average plate power is half that which would be taken by an equivalent straight class A amplifier. This economy is not obtained at the expense of fidelity. The fine quality delivered is due almost entirely to the transformers used.

The unusual simplicity of construction and wiring is apparent at a glance. The input transformer has primary terminations to match a universal line. This transformer is coupled to the grid of a 6J7 tube triode connected. The 6J7 tube has the unusual good amplification factor of 22 and is non-microphonic. This tube is again transformer coupled to the 6C5s. The input transformer from the 6C5s to the four 6F6s is of a special type designed specifically for the purpose. The output transformer is also critical and should be the exact impedance to match the tubes. This transformer is quite a husky affair and will handle the entire output without saturation. Output is provided for 4, 8, 16 and 500 ohms.

It is, of course, necessary to have a power supply with good regulation because of the difference of plate current at no-signal and full output. See Figs. B and 2. This also explains why self-biasing is not used. The power supply has been especially designed to take care of this requirement. The internal resistance of the plate supply is quite low and the D.C. regulation does not exceed 10 per cent. The resistance of the grid supply for the 6F6s is essentially zero, since fixed bias is used. Bias voltage is obtained through a separate rectifier system using a 5Z4 rectifier in a half-wave circuit.

The amplifier is extremely flexible, both electrically and mechanically. By placing the A.F. amplifier and the power supply on separate chassis, the possibility of hum pick-up is made negligible. It can be used for rack or table mounting.

It is a difficult proposition to find a suitable volume control that will not introduce distortion. In fact, it is really impossible, without resorting to a "pad." The T pad as shown in the diagram is 500-ohm unit. If a mixer circuit is required it may be connected as shown in Fig. 3 A and B. Care should be exercised in the choice of the T pads. They should be of the tap switch (Continued on page 240)

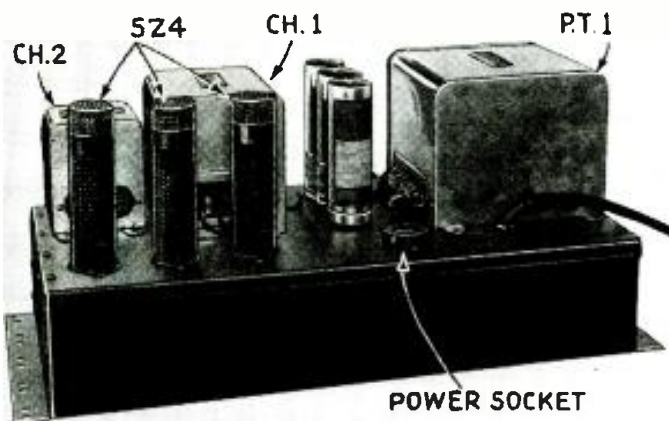
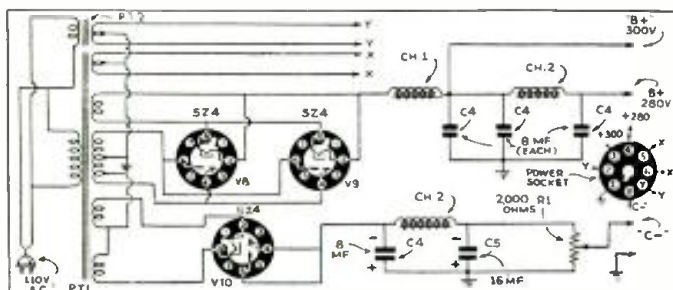
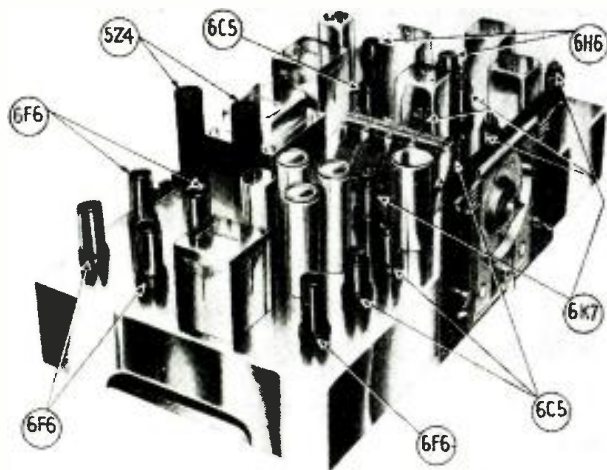

Fig. B, above; Fig. 2, below—the power supply.





AN 18 METAL-TUBE ALL-WAVE SUPERHET.

Metal tubes and all-metal construction are the features of this new deluxe model receiver. Range—4½ to 2,000 meters!!

W. A. SMITH*

permitting the set to be designed closer to the proper operating point of the tubes without fear of variations in the tube constants causing trouble.

The tube complement is made up of five power pentode output tubes bearing the number 6F6. Four of these are used in the output stage in push-pull parallel giving over 20 W. of undistorted power and necessitating a specially designed loudspeaker capable of accepting this output. The fifth of these power pentodes is used as a driver for the preceding audio stage.

The new 6K7 is a very worthy replacement for the old 6D6. This R.F. pentode is very stable in operation and very uniform in results. Five of these little iron men are used in the R.F. and I.F. amplifiers as well as in the mixer stage.

Outstanding among these metal tubes is the 6C5, which is a detector-amplifier triode that is a radical departure from past practice. Heretofore all triodes have been designed as R.F. amplifiers with the requirement that the inter-electrode capacities should be low. This resulted in poor operation in audio circuits. This new 6C5 is specially designed for audio work and makes a remarkable low noise level audio amplifier.

Four of these metal triodes (Continued on page 250)

THE NEW Midwest Deluxe 18-tube radio is designed around the new metal tubes and uses these new metal tubes throughout, entirely eliminating glass tubes in all sockets with a resulting improvement in selectivity, sensitivity and a marvelous increase in fidelity of tone, on account of the more rigid construction and greater uniformity of these new tubes. Also it has been found possible to extend the tuning range to less than five meters without sacrificing any other portion of the tuning range all the way to 2,000 meters with the exception of a small gap for I.F. amplification as is customary.

These new tubes appear to be entirely justified in spite of the large selection of tubes already available and in spite of their slightly higher cost. They are much more uniform,

*Engineering Dept. Midwest Radio Corp.

A 3½ W. METAL TUBE A. F. AMPLIFIER

This metal tube amplifier has many uses both for P.A. work, inter-office communication, signalling and call systems, radio set amplification, etc. It is very ruggedly made.

THEO. SCHMALZRIEDT*

IN designing this amplifier, prime consideration was given to the production of high gain, wide frequency characteristic, simplicity and low initial cost.

After careful consideration, the new metal tubes, types 6F5, 6F6 and 5Z4 were chosen. This tube combination lends itself beautifully to the design of an amplifier of this type.

As shown in the circuit diagram, which gives the constants of the components, the input tube—the 6F5—is resistance-capacity coupled to the 6F6, providing a gain of about 75 db. with an output of 3½ W. This combination of high-mu triode and power pentode, resistance-capacity coupled with the values indicated precludes feed-back or other types of instability.

The absence of coupling transformers permits a frequency characteristic of 50 to 10,000 cycles with a variation

of not more than 5 db.

Excitation of the speaker field is provided by means of a socket which serves at the same time as the termination of the amplifier output.

The gain of the amplifier is sufficient so that a carbon microphone may be used for close talking, if desired. A high impedance phonograph pickup may be connected directly to the input without the use of any transformer.

No input or output transformers are provided, permitting the user a wide choice of applications for this unit. Thus, it may be connected directly to the detector of a radio tuner, providing high quality audio amplification. A line-to-grid transformer may be connected to the input of the amplifier permitting amplification of sounds from a microphone or phono. pickup at a distance.

The choice of metal tubes for this amplifier adds to the rugged construc-

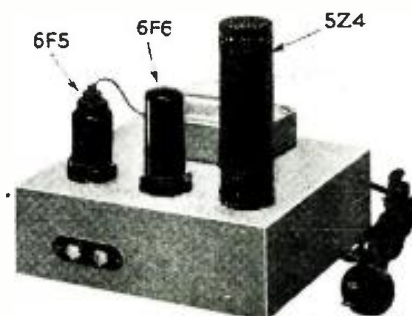

The chassis with the three metal tubes in place—note the neat appearance.

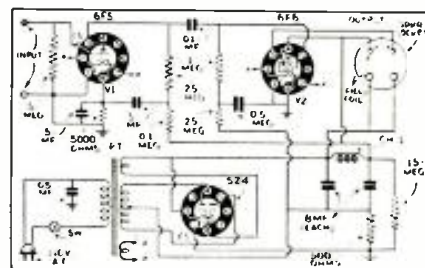

The circuit of the amplifier. The speaker plug also connects the field coil to the power supply circuit.

tion, which is sufficient to withstand the abuse to which a P.A. and general purpose A.F. amplifier is subjected. The solidly made chassis, with all small parts mounted below-board, in such a manner that no ordinary handling will affect the operation, adds to the feeling of reliability created by the neat appearance.

*Consolidated Radio Prods. Co.

AN ULTRA-MODERN METAL-TUBE CHECKER

Radical departures in electrical and mechanical design as well as convenience to the user make this unit outstanding! A schematic circuit illustrates many technical improvements.

O. J. MORELOCK*

A NEW TUBE checker which represents a striking departure from former types, in appearance, electrical and mechanical construction, and in convenience to the user has just been placed on the market by the Weston Electrical Instrument Corp., Inc. This tester has sockets providing for all pin combinations for glass and metal tubes now commercially available, and provisions for other combinations which may be introduced in the future.

The circuit, shown in Fig. 1, incorporates a fundamental advance in testing tubes on the basis of total emission, in that three separate loads, one for general-purpose tubes, one for battery types and one for diodes, are available as required at the throw of a switch. Thus, the total emission tests for each type of tube may be obtained on a specific load basis and without possibility of damage to the tube

*Radio Eng. Dept., Weston Electrical Inst. Corp.

structure. (An important feature.)

A group of seven individual "electrode" switches, grouped on the center operating panel of the tester provides a highly flexible means of setting up the various electrode combinations for any tube. Individual portions of all tubes may be checked, no matter how complicated they may be, including individual diode readings and separate portions of double tubes; and all without removing the tube from the socket.

A complete inter-element neon short test, carried out while the tube is hot in the socket used for emission readings, is made available by simply throwing the "short-test" switch, previous to the regular test operation.

A self-contained transformer supplies all necessary potentials from 105 to 130 V. A.C. line. The line voltage adjustment on the center panel, operating in conjunction with a direct reading meter, is connected through a



Fig. A. The tube checker with its cast aluminum case.

toggle switch to permit a check on line-voltage at any time while a tube is under test.

The unit is completely enclosed in a durable cast aluminum case (Fig. A), divided in the center by an engraved bakelite panel section carrying the indicating instrument and all controls. The meter itself is of modern rectangular shape with an easy-to-read scale. Four sockets are located on each side of the center panel, providing all standard pin layouts from 4-prong to 8-prong, inclusive.

Fuses within the bakelite plug on the

(Continued on page 234)

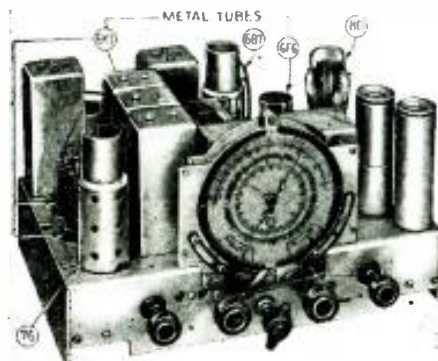

Fig. A. Here is the all-wave chassis.

METAL TUBES in R.F., frequency-converter and I.F. stages are a feature of this 7-tube receiver, which covers the frequencies from 18,300 kc. to 535 kc. in three extended wavebands. The first covers 5,750 to 18,300 kc. (52.2 to 16.4 meters) for foreign broadcast and domestic daytime reception; the second, covers 1,715 to 5,800 kc. (175 to 51.8 meters) for foreign short-wave, intermediate short-wave and police broadcast reception; and the third covers 535 to 1,730 kc. (560 to 173 meters) for general broadcast reception.

The set is equipped with a sensitivity control which eliminates inter-station noise on average-strength signals, assuring quiet reception at all

*Chief Eng'g., Wholesale Radio Service Co., Inc.

A NEW 7-TUBE ALL-WAVE RECEIVER

An unusual combination of metal and glass envelope tubes in this superhet. supplies the high gain. (See diagram.)

HUBERT SHORTT*

times except when tuning in extremely weak and distant signals. This control is mounted on the back of the volume control, so that the same knob controls both functions.

A "high-fidelity" switch on the chassis spreads the selectivity of the I.F. circuits, to prevent side-band cutting, thus permitting the passage of high frequency notes. This increases the quality of reception for local stations to supply the greatest enjoyment of the programs.

Two additional features—diode A. V.C. and full-range tone control—make the set thoroughly modern.

DESIGN FEATURES

The sensitivity of the set is rated at from ½-microvolt absolute on the standard broadcast band, to 2 microvolts absolute on the foreign short-wave band. The selectivity is ample for separation of all stations (under normal broadcast conditions), being rated 28 kc. broad at one thousand times down. This indicates non-interference between signals of a field

strength ratio of anything less than 1,000 to 1 at 14 kc. separation.

The undistorted output of the set is 3 W., assuring volume considerably in excess of room requirements. Fidelity is flat within 6 db. from 100 to 5,500 cycles. Current consumption is 68 W. at 115 V. 60 cycles.

The control arrangement includes an illuminated airplane dial calibrated in kc. with colored band-indicator. Five knobs comprise the controls—one knob for tuning; another for volume and sensitivity control; another for tone control; a fourth for wave-band switching and the fifth for high-fidelity or I.F. spreader control.

The tubes used in this set are a combination of metal and glass types. Three type 6K7 tubes are used as R.F. amplifier, frequency converter and I.F. amplifier, respectively. Another metal tube, a 6F6 is used as the A.F. power output tube. A 6B7 glass type tube is employed as diode detector, A.V.C. and A.F. amplifier; another glass tube, a 76 is the oscillator and a

(Continued on page 235)



TESTING METAL TUBE

A PORTABLE-TYPE METAL-TUBE CHECKER

This unit will check all tubes including the new metal types; also, it can be used as a point-to-point set analyzer.

MILTON REINER*

The counter-type unit, above and circuit, below

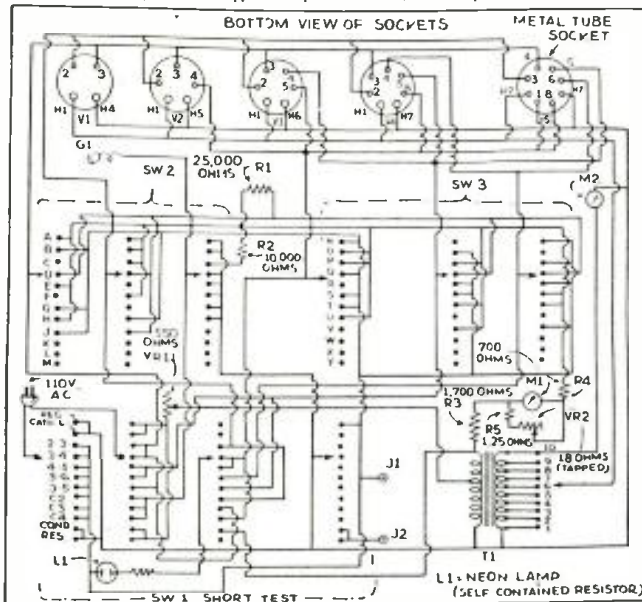

A COMPLETE, modern tube checker was described by the writer in the May, 1935, issue of *Radio-Craft*, and a great many readers sent to the author for detailed diagrams and instructions. Since writing the article, the new octal-base metal tubes were designed and are now actually on the market. The large number of inquiries and enthusiastic comment is strong evidence of the need for a good economical instrument.

Therefore, the previous tube tester has been redesigned to accommodate the new tubes and has been further improved to incorporate some general testing features which in most instances will permit it to serve as a complete trouble shooter for a radio receiver. This means that a single tester will serve both as a tube checker and as an analyzer for point-to-point testing. The physical layout has been improved and a new large meter adds considerably to the appearance as well as ease of operation.

This new 5-in. fan-type meter costs very little extra. It is a D'Arsonval moving-coil meter having an accuracy within 2 per cent. The scale length is about 60 per cent longer than the meter scale used in the first model!

The major portion of the panel is sloping for easy operation.
(Continued on page 243)

*Chief Eng'r., Radio City Products Co., Inc.

A 3-BAND METAL-TUBE SUPERHETERODYNE

This all-wave superhet. set features the small-size chassis made possible by the use of the 6 metal tubes.

H. W. PARO*

THIS 6-tube superheterodyne set, covers the wavelengths from 18 to 550 meters, in three bands. The circuit employs 6 of the new metal tubes, one 6A8 frequency converter, one 6J7 I.F. amplifier, one 6H6 combined second-detector and A.V.C., one 6F5 first A.F. amplifier, one 6F6 power

amplifier and one 5Z4 rectifier. The chassis is equipped with a large airplane-type dial, facilitating easy tuning on the three wave-bands. The dial provides smooth vernier action so essential to short-wave tuning.

A glance at the schematic circuit below, shows the outstanding features of the set. It has automatic volume con-

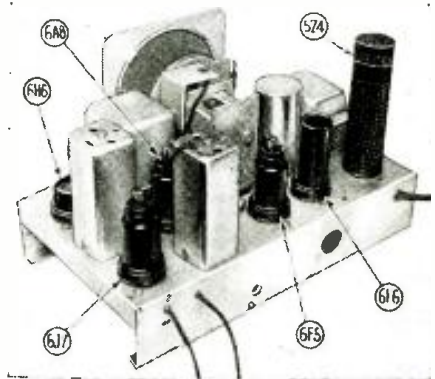

The chassis of the metal tube set

control, provided by the second diode plate of the 6H6 tube. A manually-operated tone control permits adjustment of the high-frequency response to suit individual taste.

The set is sold in an attractive cabinet 12x14½x7 ins. deep. The power
(Continued on page 239)

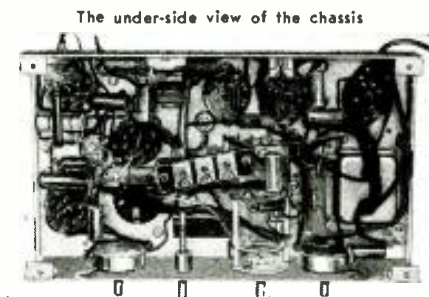

The under-side view of the chassis

The circuit showing the band-switching arrangement and other features

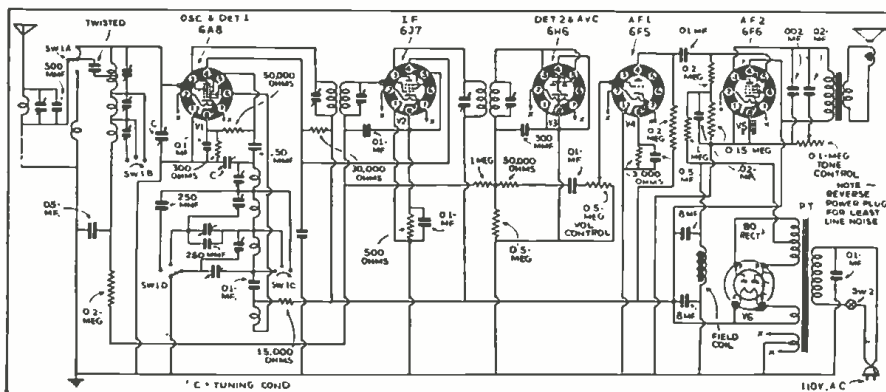

THESE 1935-'36 RECEIVERS FEATURE METAL TUBES

The Metal Tube Era in radio construction is here; one line* introduces a sentry box, permaliner, sliding-rule tuning scale, and stabilized reproducer, as shown by diagram.

DEVELOPED, designed and manufactured by the "House of Magic," 8 sets have just been introduced, using from 12 to 5 tubes.

The table model No. A70 three-band set.



They incorporate five major developments, in addition to many improvements over conventional types of radio receivers.

All offer both standard- and short-wave reception features and several have extended tuning ranges for ultra-short waves. One has five bands, two have four bands, two have three bands and three have two bands. They are known as models A125, A87, A82, A75, A70, A65, A63 and A53, respectively.

Outstanding among the developments is the new metal tube, used entirely in these new sets. Other exclusive advances are the sentry box, the permaliner, the stabilized dynamic speaker and the sliding-rule tuning scale, described below.

THE METAL TUBE

The new metal tubes are not only much smaller and more sturdy than conventional glass tubes, but offer many electrical improvements.

(Continued on page 234)

*General Electric Co.



Above, the appearance of the A125 console.

Below, the A63 metal-tube chassis.

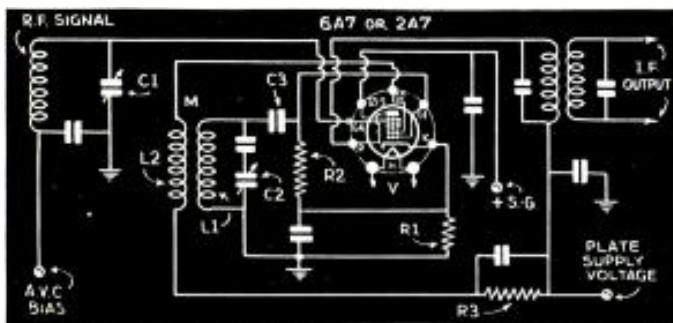

THE "METAL-GLASS" CONVERTER TUBE IN ALL-WAVE SETS

This article explains some facts about making pentagrid converters for all-wave sets.

ROBERT J. E. WHITTIER*

ABOUT A year ago, the lower priced radio receivers started to include one or more short-wave bands. The 6A7 was the only tube which was economically feasible for this use. The development of low-capacity switches encouraged manufacturers to make receivers which would cover all wavelengths down to 20 meters or less. So long as these all-wave receivers used 4 or 5 steps to cover all the wavelengths, it was possible to adjust the oscillator circuit conditions so that practically any manufacturer's 6A7 would operate satisfactorily. However, in some cases, the oscillator circuit losses were such that certain tubes would not oscillate at the low frequency end of some of the short-wave bands! Some of the all-wave radio sets used less steps and a greater frequency spread on the tuning condensers in order to cover all the wavelengths, which made these sets very critical as to operation over their entire wave band. It was usually found that some 6A7s would operate over the entire band, while other 6A7s of a competitive manufacturer would not operate on these certain wavelengths.

Several months ago, one manufacturer made a thorough study of all 2A7s and 6A7s, with regard to their transla-

tion gain and their operation under unfavorable circuit conditions, such as found in the radio sets mentioned. It was found that some tubes which would operate under the most unfavorable radio set conditions, would not have as good a translation gain, as tubes which would not operate over the entire wave band. Many types of pentagrid converters were made, in order to study the effect of different tube characteristics in several popular radio sets. Since the tube characteristics affecting translation gain, strength-of-oscillation, or starting of oscillation under unfavorable

(Continued on page 244)

Fig. 1. Some of the important factors in the design of 2A7, 6A7 and 6A8 tubes for all-wave receiver use are indicated here.

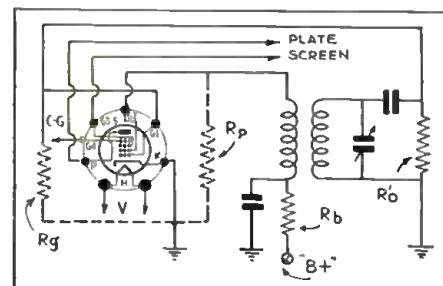

*Manufacturer's name on request.

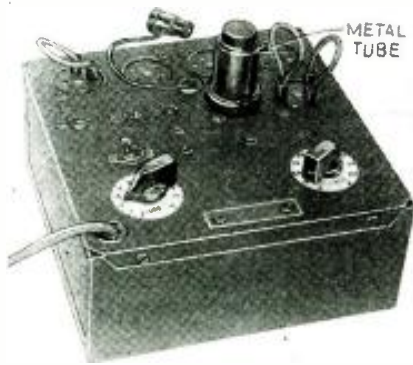

A METAL-TUBE "COMBINATION TESTER"

While primarily designed as an "improved" tube tester, this unit may also be used for aligning and continuity tests.

JOHN W. MILLION, JR.*

EXPERIENCE in recent years with modern circuits has shown many cases where tubes of standard mutual conductance failed to perform properly in the radio set. This was because the conditions under which the mutual conductance was tested were not the same as those existing in the receiver. Even sales campaigns were built around "set-tested tubes." This condition brought into being this Combination Tester.

The emission test tells whether the tube filament or cathode provides enough electrons for the tube to function properly. Along with this test goes a short test to determine shorts or leaks between elements. If the emission is satisfactory and there are

no shorts and leaks, the tube has been tested as thoroughly as is possible by any tester.

There remains the test as to the performance in the set and this test must be made after a mutual conductance test the same as after an emission test. In the case of a complex tube (such as the 6A7), there is not even a satisfactory laboratory test for performance except insertion in the

particular receiver under the exact conditions of operation.

THE "NEON METER"

This unit tests the emission using the tube under test as a rectifier. The emission current is measured by a calibrated neon meter. The principle of this meter is the use of the lighting of the neon as the fixed meter reading.

(Continued on page 245)

The circuit of the Combination Tester, below. The under side of the tester panel, right.

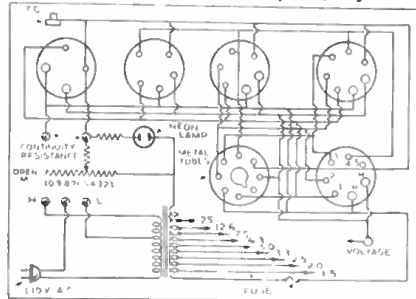

*Million Radio and Television Labs.



THE NEW BRIDGE-TYPE VIBRATOR-"B" TESTER

This bridge-type vibrator tester will also test condensers and type 84 rectifier tubes—it is direct reading.

WM. W. GARSTANG*

FOR two years, the laboratory of a well-known manufacturer of test instruments worked on the design of a tester for vibrators which would actually determine the goodness of a vibrator on a direct-reading meter. Standard test equipment was not practical due to the difficulty in making readings.

The circuit finally developed is based on the bridge principle, whereby the current input is compared to the current output of a standard power supply. Using a constant resistance load on this power supply, it is obvious that the ratio of the two currents will determine the efficiency of the vibrator and the power supply.

Manufacturer's name on request.

It was found that the difference between a new vibrator and a vibrator which was considered to be defective was approximately only 15 per cent variation in watts efficiency. Consequently it was necessary to develop a meter which would have a sizable deflection for a 15 per cent variation in power efficiency.

An examination of the circuit shows how exceedingly simple it is. The difference between the readings for half-wave and full-wave rectifiers was compensated for by tapping the bridge. (Basically all vibrators of the full-wave type, regardless of manufacture should have the same efficiency, and for this reason, the tester is an unbiased judge of the quality of the vibrator being tested.)

The tester also includes a unique R.F. test which gives a very positive glow of the indicator lamp if the vibrator has undue R.F. interference.

Since the majority of failures in vibrator power units is caused by defective buffer condensers and rectifier

tubes, a neon tube condenser tester is included in the bridge.

An additional feature of the device is the fact that 84-type rectifier tubes can be tested by inserting a "good" vibrator in the bridge and substituting the doubtful 84-type tube for the one in the standard power supply of the tester. The meter will then read correspondingly "good" or "bad."

(Continued on page 239)

The circuit of the bridge-type tester.

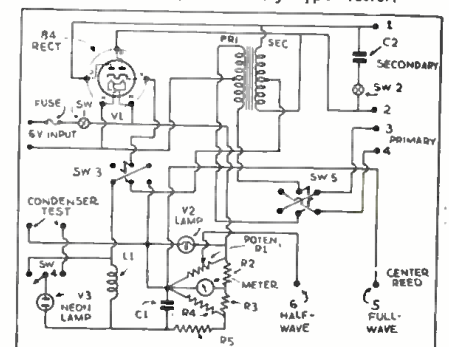

AN OSCILLOSCOPE ANALYZER-ADAPTER FOR METAL TUBES

This unit has the dual purpose of rejuvenating obsolete analyzers and facilitating cathode-ray analysis work.

E. J. SAMPSON*

THE ANALYZER-ADAPTER described here was designed to permit the use of a cathode-ray oscilloscope for radio set testing and analysis work. The adapter conveniently allows the two vertical plates of the oscilloscope tube or the vertical plate amplifier of the unit to be connected to different circuits of a radio receiver, amplifier, etc. When used in this way, it saves a great deal of time and con-

*Alden Products Company

The rear of the panel with the parts in place.



veniently allows test to be made of the input signal, output signal, A.V.C. voltage, screen-grid voltage, oscillator voltage, I.F. signal waveforms and voltage, besides the wave shapes of detector and A.F. tubes, "squench," "aligning," "tuning," "phase inverter" tubes, etc.

The analyzer-adapter unit can also be applied to the use of modernizing obsolete set analyzers to permit analysis of the latest sets using metal tubes and all the "trick" circuits in vogue today. The use of a multi-meter or an old analyzer with the adapter equals the most up-to-date equipment obtainable, and at a cost much lower than a new analyzer.

The circuit diagram, Fig. 1, shows the principle upon which the unit works. The upper jacks marked V.P. connect to the vertical plates of the oscilloscope (or the amplifier for these plates) while the lower jacks marked V.P. are used with jumpers for select-

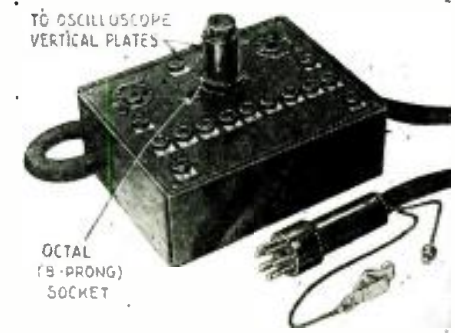

The complete analyzer-adapter unit.

ing the tube circuit for analysis. The jacks connecting to the tube socket prongs of the analyzer and the analyzer plug, marked 1, 2, 3, etc., with the exception of the heater jacks are made in such a way that when the type 111D plug is inserted, the circuit is automatically opened and the current passes through the meter. This permits current measurements in any circuit except the heaters.

When the type 112S plugs are inserted, in these same jacks, they remain closed, so that a simple contact is made to the wire, permitting voltage measurements.

To use an oscilloscope with the analyzer-adapter, the V.P. jacks at the top connect to the vertical scanning terminals, as explained above, and the lower jacks V.P. connect to jumper wires which complete the circuit to the correct tube elements.

(Continued on page 235)

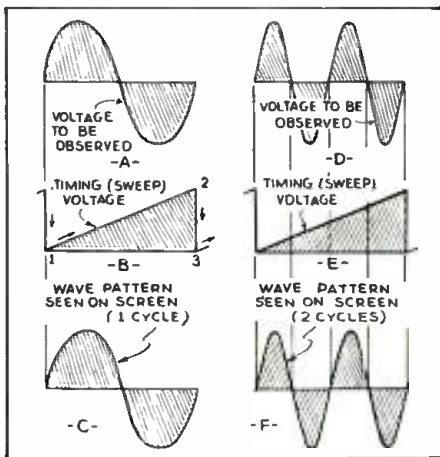
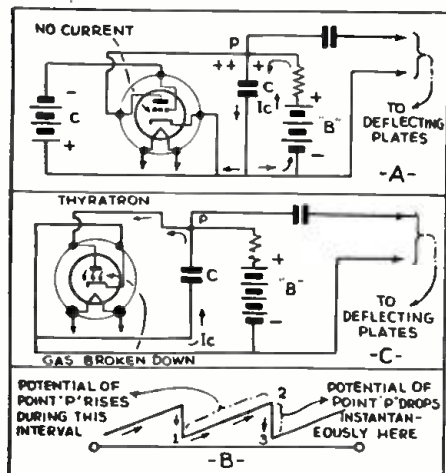

Fig. 1, above. Fig. 3, below.



THE SWEEP VOLTAGE FOR CATHODE-RAY TUBES

In cathode-ray oscilloscope analysis, the timing voltage is one of the most important factors involved, as explained.

ALFRED A. GHIRARDI*

THE VARIOUS patterns which may be observed with the cathode-ray tube when two independent voltages are applied to its deflecting plates are of value in some applications of the cathode-ray tube, but the operator must be entirely familiar with the significance of most of the different complex images that can be formed so that he can identify the pattern and tell at once what it indicates regarding the phase relation, frequency relation and wave form of the two applied voltages.

Very often it is desired to observe the wave form of a single current or voltage. This is the case when I.F. amplifier circuits are being aligned or adjusted. This requires that the voltage which is to be observed, be connected to one set of the deflecting plates—usually the horizontal plates.

Let us assume that the voltage to be observed is that shown at A of Fig. 1 and that it is applied to the horizontal deflecting plates. If this is done, the varying voltage on the horizontal

plates will cause the beam to oscillate
(Continued on page 246)

Fig. 2. A typical saw-tooth sweep circuit.

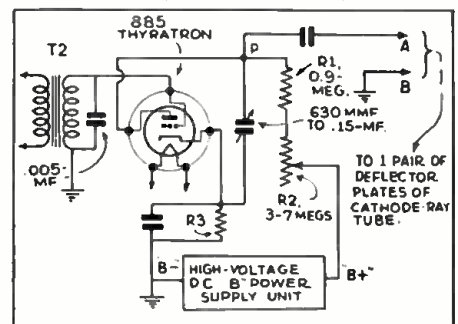

Fig. 4. A motor-driven saw-tooth oscillator.

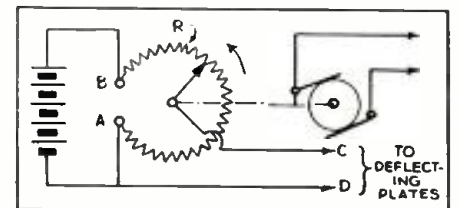

TABLE OF TUBE COMPARISONS	
METAL TUBES	GLASS TUBES
5Z4	80
6A8	6A7
6C5	76 (6C5 HAS AMPLIF. FACTOR OF 20)
6D5	45 (6D5 HAS AMPLIF. FACTOR OF 4.7)
6F5	TRIODE SECTION OF 75
6F6	42
6H6	DIODE SECTION OF 75
6J7	77
6K7	78
6L7	NEW PENTAGRID MIXER-AMPLIFIER.

METAL VS. GLASS RADIO TUBES

Major differences of the new metal and older glass tubes, including inter-electrode capacities, are discussed.

ALBERT A. BOMBE*

METAL tubes wherever they are shown and discussed, raise the question, "How do metal tubes compare in characteristics with our present glass types?"

With some basis of fact it might be said that the new metal tubes arrived somewhat ahead of the new need in radio tube design. Consequently the metal tubes follow glass types in general characteristics and differ principally in capacities and the division of certain special-purpose tubes which have two sets of elements in the glass types and are divided into separate metal tubes, each containing one set of elements.

Several of the new metal tubes almost duplicate in characteristics glass tubes popular in receiver design during the last year—for example:

6J7—The metal 6J7 closely matches the glass 77.

6K7—The metal 6K7 is similar to the glass 78.

6A8—The metal 6A8 has characteristics matching the 6A7.

6F6—The metal 6F6 matches the glass 42.

5Z4—The metal 5Z4 rectifier has a rating similar to that applied to the old familiar glass 80.

6H6 and 6F5—The glass 75, popular since its introduction, has been divided for metal tube production with the

diode section appearing in the new metal 6H6, and the triode elements comprising the new metal 6F5.

6C5—The general-purpose metal triode, type 6C5, is (Continued on page 243)

DIRECT INTER-ELECTRODE CAPACITIES							
METAL AND GLASS TUBE TYPES	CONTROL GRID (No. 4) TO PLATE	R. F. INPUT (Cg-K)	OSC. OUTPUT	OSC. INPUT	MIXER OUTPUT	GRID TO PLATE (Cg-P)	OUTPUT CAPACITY (P-K)
6A8	.05-MMF.	13 MMF.	45 MMF.	7 MMF.	13 MMF.		
6A7	0.3-MMF.	8.5 MMF.	5.5 MMF.	7 MMF.	9 MMF.		
6C5		4.5 MMF.				2 MMF.	2 MMF.
76		3.5 MMF.				2.8 MMF.	2.5 MMF.
6J7		8 MMF.				.002-MMF.	12 MMF.
6C6		5 MMF.				.01-MMF.	6.5 MMF.
6K7		8 MMF.				.002-MMF.	8 MMF.
6D6		4.7 MMF.				.01-MMF.	6.5 MMF.
6L7	.001-MMF.	8.5 MMF.		11.5 MMF.	13 MMF.		
NONE							

*Sales Eng. Dept., Raytheon Production Corp.

THE NEWEST IN TREASURE LOCATORS



A high-frequency, single-unit metal locator which can be made quite sensitive by following the instructions.

R. D. BURCHARD, JR.*

THERE is an ever increasing demand for a practical, yet sensitive device which can be used not only by prospectors for geophysical surveys, but also (and primarily) for locating metallic bodies—for instance, a dime at a few inches distance, or large bodies of metal several feet away.

While many such devices have been designed, most of them have some inherent difficulty which makes them impractical for such work—either they are: (1) too heavy; (2) too difficult

to operate; (3) too critical, requiring frequent readjustment; or, (4) what is most common, they are too insensitive to be of practical service.

The device described here is both light in weight and stable in operation, and the sensitivity is above that ordinarily found for such instruments. The balance is so sensitive that a single coin can be detected when it is brought within several inches of the search coil—and of course the distance increases greatly for larger bulks of metal or conductive bodies.

(Continued on page 236)

*Radio Metal Locating Co.

Fig. A, left. The locator unit ready for use. The search coil is kept as close to the ground as possible.

Fig. 1, right. The circuit of the oscillator and the receiver units. A common "A" battery is used to reduce weight; separate "B" units are used to secure maximum stability.

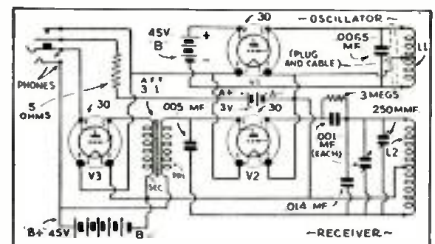

MAKING AN ALL-WAVE SERVICE OSCILLATOR

This unit includes facilities for making a P.A. system from any radio receiver.

MICHAEL BLAN



ONE OF the major considerations brought home to the Service Man and radio experimenter during the last year is that it is very difficult to get along without a test oscillator. Every one who does any radio work has a desire or need of one. Without one, it is impossible to perform satisfactory service work or even construct a superheterodyne receiver for one's own use. Many no doubt, cannot afford the expense involved for the better grade units on the market; and others, though capable of constructing a unit find that the calibration is too difficult and tedious an operation and are therefore still without this indispensable item.

For the benefit of those who want to build their own oscillator that overcomes all the heretofore mentioned difficulties and furthermore includes new features that are not included even in high-priced signal generators, then here is the job you have been waiting for.

A cursory glance at the diagram discloses a battery-operated all-wave oscillator utilizing two type 30 tubes, one the R.F. oscillator in a tuned-grid circuit and the other an A.F. modulator. The heart of the oscillator is the 24 coils that are used for the R.F. oscillator. These coils are obtainable completely wired and are contained in a shielded drawn-copper can together with an 8-position rotary switch and a small bypass condenser. Due to the construction and the efficient shielding provided by the can, high efficiency and low leakage are obtained which results in uniform R.F. output voltage over the entire range of the oscillator.

When used with the specified parts the frequency coverage of the oscillator is from 90 kc. to 25,000 kc. This entire range is covered by the fundamental frequencies generated by the oscillator, no confusing harmonics being used. A front panel switch is used for selecting one of the eight ranges that cover the following bands:

- (1) 90-200 kc.; (2) 200-400 kc.; (3) 400-800 kc.; (4) 800-1,600 kc.; (5) 1,500-3,100 kc.; (6) 3,100-6,800 kc.; (7) 6,800-14,000 kc.; (8) 14,000-25,000 kc.

The tuning dial to which is affixed a direct-reading scale for each band covered provides an accuracy within 2 per cent. For those who require greater accuracy of calibration, a correction chart should be made that indicates the error for any particular dial reading. To obtain this accuracy, on no account should any parts other than those specified be used. The reason why the entire combination of parts must not be changed is that the scale is frequency calibrated on the basis of a given inductance and a definite variation of capacity in respect to tuning dial position. The resultant frequencies imprinted on the dial would not apply if any part of the combination should be changed.

When the 2-position toggle switch Sw.2 is snapped over to the modulation position the output is modulated with a pure sine wave 1,000 cycle note. There are, however, certain applications when the output requires no modulation such as when used with a cathode-ray oscilloscope or when used as a station finder. To obtain unmodulated output the same switch is snapped to the off-

position.

USE AS P.A. SYSTEM

To make a receiver a public address system, connect a wire from the output post of the signal generator to the antenna terminal post of the receiver and connect a microphone or phono pickup to the tip jacks below the tuning dial. The switch Sw.2 must be in the off position when speaking into the microphone. Tune the oscillator to some frequency within the range of the receiver and tune the receiver the same as when tuning for a station. Volume can be controlled at the receiver or with the attenuator on the oscillator. This feature utilizes all the tubes in the receiver and full volume output is assured without making any changes to the receiver. When used with a medium-priced microphone as shown in the photograph the quality emanating from the loudspeaker surpassed that of any of the DX stations. The reason for this is that there is no intervening factor such as distortion due to transmission over long distances or fading. The quality, of course, also depends upon the receiver, but if broadcast stations are received with good quality then one will know in advance the capabilities of this modern method.

USE WITH OSCILLOSCOPE

Another desirable feature included is the sweep circuit jack. When using a test oscillator for aligning receivers with an oscilloscope, it is necessary to parallel a sweep condenser across the tuning condenser of the test oscillator. Another use to which this jack can be

(Continued on page 237)

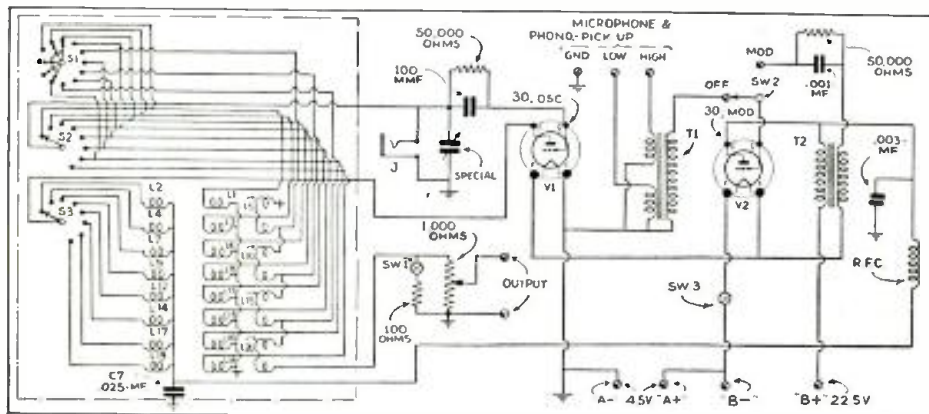
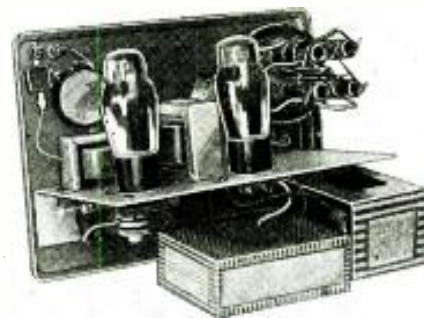
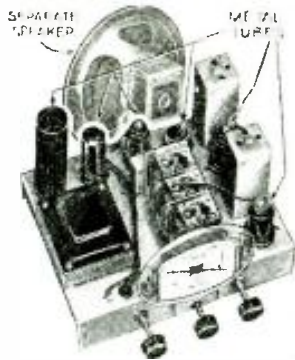

Fig. 1, left. The circuit, including parts values.

Fig. 2, below. The rear of the oscillator chassis with the coil shield removed.



THE LATEST RADIO EQUIPMENT



6-tube all-metal set. (802)



Metal-tube tester. (803)

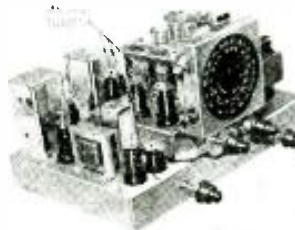

Long-wave "metal" chassis. (804)

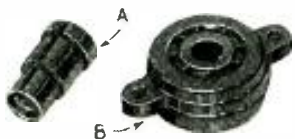

Above. Dual clip, octal socket (805)

Below. New "metal" console. (806)

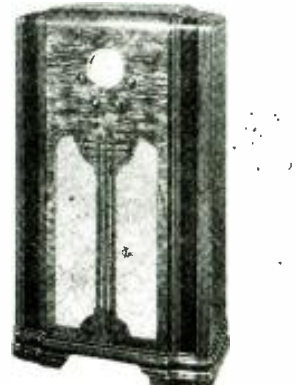

6-TUBE ALL-METAL SET (802)

(Allied Radio Corp.)

THIS all-wave set covers from 17 to 565 meters with no skips. The following metal tubes are used: 1-6H6, 1-6F5, 1-6K7, 1-6F6, 1-6A8, 1-5Z4. The large airplane dial is calibrated directly in kilocycles, and has the various bands printed on it. A separate speaker is used.

METAL-TUBE TESTER (803)

(The Readrite Meter Works)

ACCOMMODATING both glass and metal tubes, this new tester is of the "English reading" type. Two meters are used, the line-voltage meter being of the shadow type. Tubes are tested under proper loads and the instrument will show the slightest leakage. The case is of quartered oak with a lithographed metal panel.

"METAL" LONG-WAVE SET (804)

THE NEW CentrOmatic tuning unit is featured in the chassis illustrated. This set uses ten metal tubes in a high-fidelity arrangement. Broadcast range is 510 to 18,500 kc.; the long-wave range 150 to 350 kc. The same chassis is available in two different console types.

DUAL CLIP AND OCTAL SOCKET (805)

(Alden Products Co.)

A CLIP designed for use with new test equipment in connection with metal tubes is illustrated at A. The large end is for use with the present glass tubes, while the small end fits the metal-tube caps. At B is a moulded octal (8-prong) socket which can be mounted above or below the sub-panel.

7-TUBE "METAL" CONSOLE (806)

FEATURING "control room reception," this console utilizes one each of these 7 metal tubes: 6A8, 6H6, 6F5, 6F6 and 5Z4; and two, type 6K7s. All-wave operation is

provided for, and there are 7 tuned circuits. The aeroplane dial is of the double-speed type, with automatic lighting on only one band at a time.

INTERFERENCE ANALYZER (807)

(Sprague Products Co.)

INTERFERENCE can be eliminated by the use of this equipment, which affords over 16 different types of filters, covering every possible need. When an adequate filter has been selected, reference to the position of the knob will show, in conjunction with a chart, just what equipment is needed to secure equivalent results. The apparatus is housed in a compact bakelite case.

IRON REPAIR KIT (808)

A KIT which furnishes all necessary small parts to repair irons and cords. Includes terminals, insulation, nuts and bolts, and many other small parts. A time-saving kit for the busy electrician-Service Man.

METAL-TUBE AMPLIFIER (809)

(Marlo Radio Products Co.)

AN AMPLIFIER using entirely metal tubes has just been announced. The apparatus is housed in a silver-crackle steel chassis of ultra-modern design. Special circuits have been incorporated to use the new tubes at their highest efficiency. The 8-tube model illustrated has a power output of 21 W., conservatively rated, with less than 5 per cent harmonic distortion. The frequency range is 20 to 16,000 cycles.

ALL-WAVE SUPERHETERODYNE KIT (810)

(Lafayette Radio Mfg. Co.)

A NINE-TUBE all-wave superheterodyne kit is available to the constructor at a very reasonable price. The range covered is 10 to 560 meters. Features include: R.F. stage on all bands, A.V.C., two manual volume controls, beat frequency for C.W. reception, two-speed dial, and many others. The cabinet and

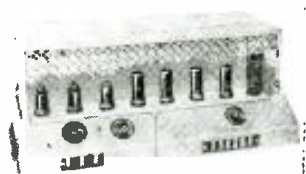

All-metal tube amplifier. (809)



Nine-tube superheterodyne kit set. (810)



Vernier attachment. (811)

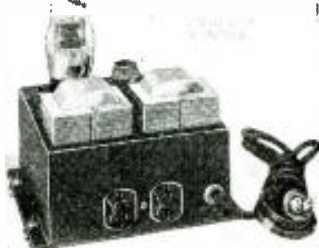

Phantom relay. (812)



Group hearing aid. (813)

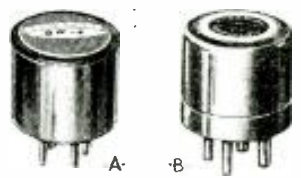

Above. Conversion plugs. (814)

Below. Metal-tube auto set. (815)

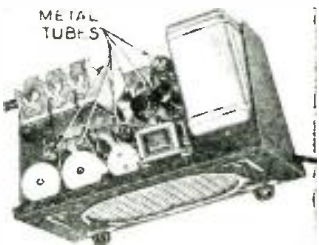

Interference analyzer. (807)



Iron repair kit. (808)



Name and address of any manufacturer will be sent on receipt of a self-addressed, stamped envelope. Kindly give (number) in above description of device.



All-wave metal set. (816)



Small electrolytic condenser. (817)



Multi-crystal microphone. (818)



Probe-lite. (819)



Above. Glass-'metal' tube shield. (820)

Below. 7-tube metal set. (821)

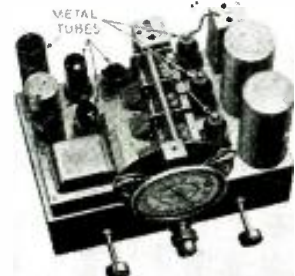

Resistance bridge. (822)

panel are finished in black crackle enamel, and are made of steel. The coil and band switch unit are pre-adjusted at the factory.

VERNIER ATTACHMENT (811)

(Blair the Radio Man, Inc.)

AN ATTACHMENT which, when put on the shaft of a condenser, enables the user to have either direct drive, or a 5 to 1 vernier action. It is only necessary to slip the unit on, tighten the set screw, and put the small pin in place. The "planetary" action is velvet-smooth and free from backlash.

"PHANTOM" RELAY (812)

EXPERIMENTERS, and others will be interested in this new electro-static device. It is operated by the approach of any body, and can be made for use on A.C., D.C., or batteries. An antenna is used, running to the point from which the control is to be exercised. Since the device works without light or any other visible means, it can be used for mysterious window displays. The apparatus is entirely self-contained.

GROUP HEARING AID (813)

(Trimm Radio Mfg. Co.)

HUM-FREE amplification is furnished by the equipment shown, for use of the hard of hearing. An extra-high-fidelity microphone is used. The reproducing units may be either headphones or bone-conduction units. A large number of units may be operated, together with a loud-speaker if so desired.

CONVERSION PLUGS (814)

DESIGNED to replace ballast tubes in battery sets which were originally made for use on dry cells, these plugs drop the 2.53 voltage of air cells to the proper potential for the 2-volt tube series. They are made in several types for different current drains.

The units are made by the following manufacturers: The Ohio Carbon Co. (illustrated—A), Continental Carbon Co. (illustrated—B), Centralab, Insuline Corp. of America, National Carbon Co., Electrad, Inc.

METAL-TUBE AUTO SET (815)

SIX metal tubes are used in this auto-radio set. Another valuable feature is the use of a

dynamotor high-voltage supply in place of the usual vibrator type unit. The input low-voltage leads are well filtered to prevent ignition noises from entering the set. A tuned antenna circuit is provided. Short-wave range is from 2,200 to 6,800 kc. The chassis slides straight out from case for servicing.

ALL-WAVE METAL SET (816)

SEVEN metal tubes are used in this latest set. The wave spectrum is covered from 540 to 18,000 kc. Each coil in the assembly is individually shielded in a separate can. The tuning condenser is rubber mounted. Tone control is provided.

SMALL-SPACE CONDENSER (817)

(Solar Mfg. Corp.)

MIDGET set builders will be interested in this new small-space condenser, which can be obtained in a complete standard line of capacities and in two voltages, 525 and 250 V. peak. They are supplied only with leads, and in cardboard cases. The 8 mf. unit shown measures 2 7/16 x 1 1/4 x 11/16-ins. high.

MULTI-CRYSTAL MIKES (818)

THESE microphones, as the name implies, are made up of various numbers of crystals. They need no energizing current and are immune to adverse weather conditions. Units of 4, 6, and 8 crystals are made and any of these may be had in single or push-pull types. The units may be mounted on a stand or on a handle for portable use. The metal cases are chrome plated.

PROBE-LITE (819)

(Thordarson Electric Mfg. Co.)

ALIGHT for use in dark corners which plugs into the electric socket. The bulb is a battery type pilot lamp. A long cord is furnished with the instrument, the handle of which is of heavy fibre.

TUBE SHIELD (820)

FITTING tightly around the glass, these shields are designed for use with the new glass-'metal' tubes, making them interchangeable with the metal tubes in sets designed for the latter. The shield is in four parts, the two main shell

(Continued on page 242)

Reproducer and field supply. (823)

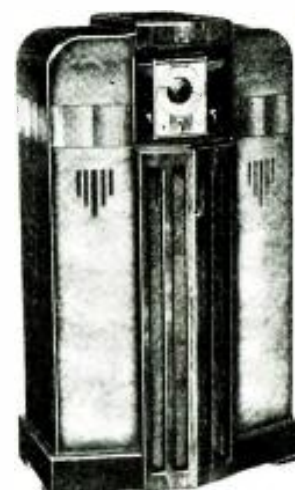
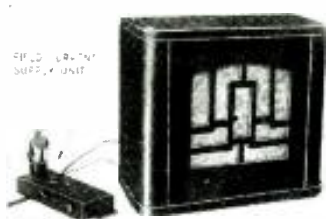

Wide wave-range set. (824)

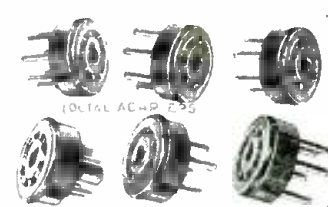

Octal adapters. (825)



11-tube metal chassis. (826)

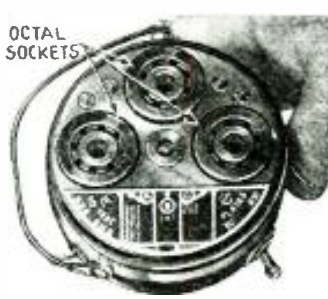

Above. Test-set adapter. (827)

Below. All-wave radio set. (828)

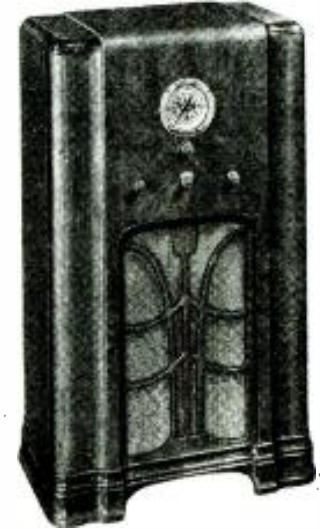

HOW TO MAKE AN "EIR" TESTER

Here is a multi-meter which should have a lot of appeal among Service Men and technicians. It is compact and wide-range.

CLIFFORD E. DENTON

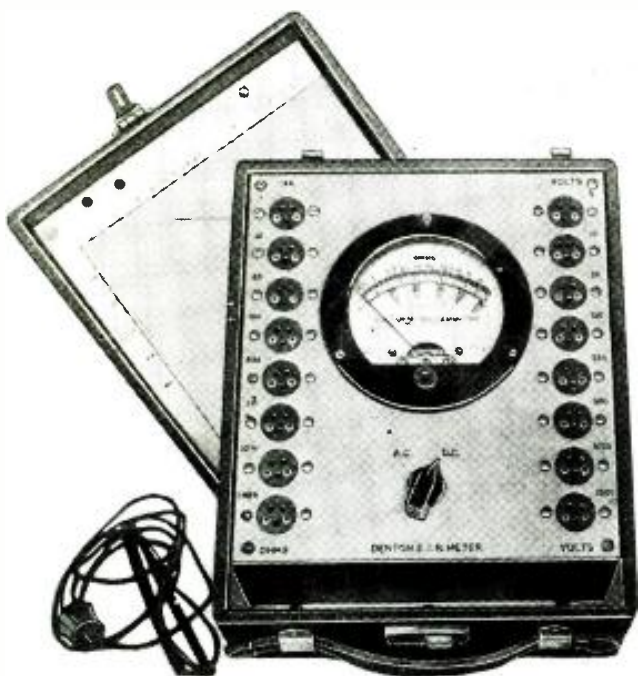

THE RAPID advancement in the design of copper-oxide rectifiers used in conjunction with high-sensitivity meters has led to the development of really efficient test equipment for radio and P.A. work.

So many types of multi-range instruments incorporating the copper-oxide rectifier in conjunction with a high-sensitivity milliammeter have been placed on the market that it has ordinarily been quite a difficult job to make up one's mind as to just which unit would be the most satisfactory.

However, an analysis of the existing instruments shows that most of the units available have more or less minimized the possible ranges due to such things as production costs and the ultimate sales price. Therefore, in planning a meter for personal use a little thought was given to the voltage ranges both A.C. and D.C. which would be encountered in conjunction with radio and P.A. testing with the result that this new meter has A.C. and D.C. voltage ranges of 0-5, 0-10, 0-25, 0-100, 0-250, 0-500, 0-1,000, 0-2,500 V. The meter selected being a milliammeter of fairly high sensitivity made it a simple matter to include shunts so that ranges of 10, 25, 100 and 500 ma. could be obtained readily. As resistance measurement plays a large part in the servicing of radio and sound equipment today three resistance measurement ranges were included having ranges of 0-1,000 ohms, 0-10,000 ohms, 0-1 meg. It will be noted upon examination of the electrical circuit, that individual batteries and individual "zero"-set rheostats are used so that it is not necessary to "reset" when changing from range to range; it was found that the settings were constant enough to provide satisfactory accuracy, even when they were not adjusted for days at a time.

Having determined on the ranges desired, the next problem encountered was the means of connecting the various multipliers or shunts in proper sequence or combination so that it would be a simple matter to use the meter at any desired range. A fortunate discovery of a very compact miniature three-prong socket and a small compact three-prong plug solved the method of selecting any range at will with a minimum of switching. It will be noted that in this unit all switching is done with a single switch and this switch simply throws the rectifier unit in or out of the circuit as required. The use of the three socket contacts permits automatic connection of the shunts, R1, R2, and R3 respectively, in the circuit. The jumper in the plug also picks up the required battery and meter current shunt circuits for the various ohmmeter ranges, thus eliminating switches of any kind in these circuits. As far as the voltage ranges are concerned, it will be noted that the small prongs of the socket receptacles are connected together, although in actual practice this would not be necessary as both of the small prongs of the plug are also connected by their jumper as indicated in Fig. 1.

From an examination of the circuit diagram, Fig. 1, and a study of the photograph and the plug arrangement, it is at once apparent that any particular range can be picked up with the greatest of ease by simply plugging into the indicated socket. This eliminates the use of two lead tip plugs and the bother so often encountered in conventional type multi-range and multi-purpose meters. The switch indicated in Fig. 1 as Sw. is thrown to A.C. or D.C., as required. For all D.C. voltage measurements, the switch must be in the D.C. position. For all current measurements in direct current circuits the switch would remain in the same position. Also note when using the ohmmeter that the switch should be in the D.C. position. The A.C. voltage readings are easy to obtain. Plug into the required voltage range, throw the switch to A.C., and you are ready to make the measurement. A special type of rectifier circuit has been developed and due to the use of this circuit it is possible to have one calibration on all scales for A.C. volts. The rectifier circuit is mounted on a small panel as shown in the photograph of the meter, and this includes the rectifier wire-wound resistor for 5 V. A.C. and another wire-wound resistor called the *compensator* which is used to adjust the efficiency of the rectifier to the (Continued on page 247)

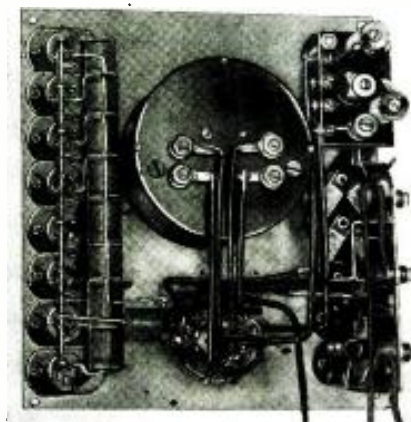

Fig. B, left. The positions of the multipliers and shunts for the meter are mounted as shown. The three-prong sockets can be seen at the left and right.

Fig. 1, right. The circuit of the instrument shows how the convenient scales are obtained.

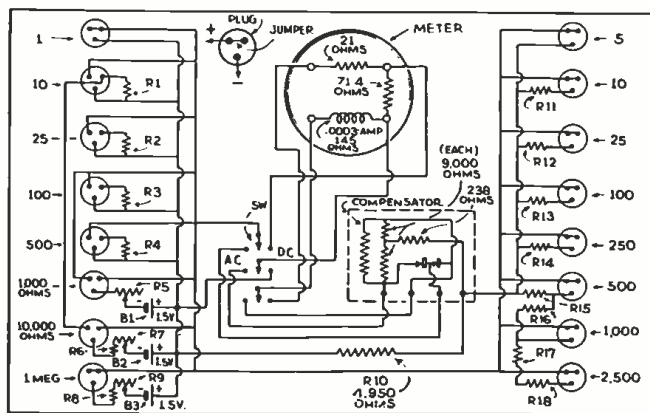



Fig. A
A typical neon sign display—indoor and outdoor.

THE "NEON" INTERFERENCE PROBLEM

The interference set up by neon signs involves problems which the Service Man does not ordinarily encounter.

J. ALBERT LYNCH

A GROWING source of radio interference is the increasingly popular neon sign. In many cases the interference is so bad as to entirely ruin radio reception in the immediate vicinity while the sign is in operation.

The neon sign, from a practical point of view, is extremely simple. In order to service these signs for radio interference we need simply a very elementary idea of the construction and contents of the completed tube, a fair idea of the construction of the entire assembly, and a thoroughly sound idea of the wiring and sources of trouble.

Our first example of a neon tube (Fig. 1A) will be a length of glass tubing about 1/2-in. in diameter, and approximately 13 ins. long. We will now insert a wire into each end of the tube, seal off the ends, apply a vacuum pump and then after pumping, inject the required amount of neon gas and seal off the glass. We now have a simple neon tube. If we now connect a transformer, rated at several thousand

volts, to these wire terminals (Fig. 1B) we will find that we have the usual red-glowing neon tube. We would now notice that the glass, except at the extreme ends, remained cool when operating. The ends would get quite warm and the wires extending inside the tube would, because of the electronic bombardment going on inside the tube, wear down and be short lived. For that reason instead of inserting a wire inside the tube we will now build up an electrode which will consist (Fig. 1C) of a metal plate surrounded by a mica sleeve inserted inside a glass envelope. A wire is now attached to the copper plate, brought out one end of the glass envelope and the envelope sealed off at that end, the other end being left open for attachment to the glass tubing used for the desired outline or letter. We now have arranged a terminal sufficiently large to give a reasonable life and so arranged as to keep cool.

As a summary, the neon letter is simply a glass tube, shaped as desired, with an electrode at each end, from which the air has been removed and the required amount of gas inserted. This is all that the average Service Man needs to know about the tubes themselves, as the actual building of the tubes is a separate trade in itself.

WINDOW SIGNS

We will now take a typical window sign (Fig. 2) and follow its construction and installation. In this sign (Figs. A and 2) the letters in the word *Logans* are approximately 4 1/2 ins. high, and in the word *bar* approximately 8 ins. high. The border outline is approximately 8 ins. larger than the letter assembly. The layout man in the sign shop, usually the sign painter, lays out a full sized pencil sketch of the sign, including a notation of the color, or colors desired, i.e., wording red, border blue, all red,—red and gold or whatever combination is desired. The sketch is then sent to the glass blower, or, more frequently, to an outside plant specializing in neon tube work. The glass blower then shapes his glass to the pattern, sending back the units complete and ready for lighting. In this case, the assembly and outline is approximately as in Fig. 2. We receive from the glass blower three separate and complete units, border—Logans—bar, any one of which can be

used alone, but which we now wish to shape into one assembly. Each unit is a continuous length of tubing with an electrode and wire terminals at each end. These units must be connected electrically in series and we will find the electrodes so shaped as to each be headed toward the electrode to which it is to connect. The circuit is as follows, one end of transformer secondary to one end of border unit, other end of border unit to one end of unit Logans, other end of unit Logans to one end of unit bar, other end of bar unit to second terminal of transformer secondary, making a complete series circuit.

RADIO INTERFERENCE

We now come to radio interference. This may be roughly divided into primary and secondary. Primary interference is caused usually by pick-up in the primary of the transformer, by the lines feeding into transformer, or, by a defective transformer. If the sign is on a separate circuit, at least a different circuit from that of the radio, and the sign is fed by a circuit run in a well-grounded metallic conduit, you will rarely have trouble from the primary source unless the transformer is defective. A line filter connected near the transformer and rated at 5 A. per transformer will usually be a positive check against primary interference provided that we have checked as to separate circuit and grounding.

The secondary source of interference is usually (Continued on page 249)

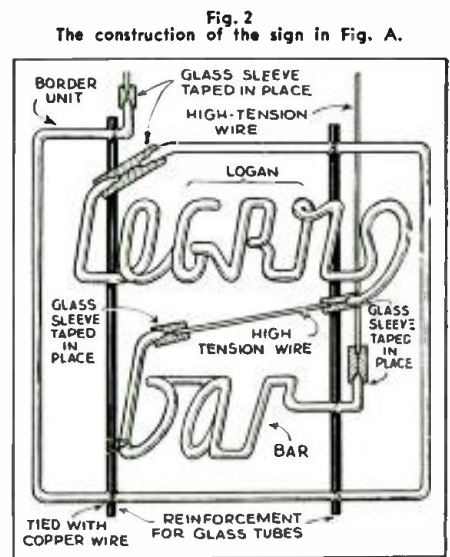
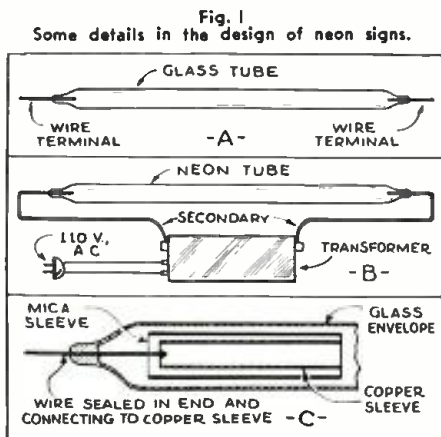

ULTRA-FIDELITY REPRODUCTION



Left, mid-range speaker No. 1; above, speaker No. 2 for over 4,000 cycles; right, speaker No. 3 for frequencies below 70 cycles.

Three reproducers, and a novel "compensated direct-impedance" amplifier having low- and high-note boosters afford exceptional fidelity.

L. MITCHELL BARCUS

SOME time ago I received a letter from a gentleman in New York who requested plans for a high-quality amplifier to fill certain specifications which he laid down. He then expressed himself as follows: "I am a collector of symphonic phonograph records but have been unable to find a really satisfactory reproducer. This is a lot to ask, I know, but perhaps you will be kind enough to comply for one who really appreciates such a thing."

The answer to his inquiry was found in the following "compensated direct-impedance" A.F. amplifier system developed by the writer.

The inherent advantages of direct-impedance audio amplification includes the elimination of bypass condensers, of breaks between tubes, and of many

sources of phase distortion, resulting in an unusually wide frequency range.

Referring to the schematic circuits, Fig. 1, two separate amplifiers will be noted. These are "intensifiers," utilized almost solely to compensate for the frequency discrimination of both phonograph records and broadcast programs. The *low-frequency intensifier* provides "depth," and the *high-frequency intensifier* provides "brilliance" in the reproduction. The relation of these two intensifiers to high-fidelity tone quality is illustrated in Fig. 2.

When the low-frequency cut-off filter is properly adjusted, the amplifier will not tend to accentuate voice frequencies, being most effective at frequencies below 50 cycles.

In the typical overall broadcast curve, which also approximately applies to transcriptions, the frequency discrimination of the R.F. tuning systems (or the mechanical limitations of recordings), was taken into account. Similarly, the dotted line representing the output of speaker No. 1 is not the response of the direct-impedance audio circuit, but takes into account the characteristics of the output transformer and the speaker.

THE SPEAKERS

No matter how perfect the amplifier may be, its actual performance rests, finally, upon the reproducers, and the manner in which they are used. Speaker No. 1 contributes toward
(Continued on page 238)

RADIO-CRAFT'S "IDEAL RADIO SERVICE SHOP" CONTEST

"The December issue of RADIO-CRAFT will contain the names and addresses of the prize winners in this \$400 contest. Gosh, what world-wide response! Even from China!"

—Signed, JACK GRAND, DIRECTOR



STILL they come! Although we knew that this contest for Service Men would go over in a big way we had no idea that even technicians in foreign countries were going to make their bid for the valuable service instruments so kindly donated by well-known manufacturers! To date, entries have been received from the following countries outside of the United States and Canada: Mexico, Venezuela, Greece, Porto Rico, France, Hawaii, Italy, So. Africa, New Zealand, Korea, and—China!

Most of the technicians who entered this contest gave considerable thought to the subject before writing to us and

everyone who sent in his letter may well feel that he has contributed something, in proportion, to the betterment of radio servicing, from the equipment angle.

The 25 names in the following list, although perhaps not those of winners, nevertheless are of high calibre (in accordance with rule 10).

John A. Cargille, 118 Elmwood Ave., East Gadsden, Ala.
Edward Flutot, 1261 E. Broadway, Whittier, Calif.
Alexander Cohen, 185 Bellevue St., Hartford, Conn.
Edward Wurgler, York, N. D.
William Longstaff, Longstaff Radio Service, 808 Buck St., Three Rivers, Mich.
A. S. Higgins, 1016 W. 53 St., Los Angeles, Calif.
Edward Flutot, 1261 E. Broadway, Whittier, Calif.
Alexander Cohen, 185 Bellevue St., Hartford, Conn.
Edward Wurgler, York, N. D.
William Longstaff, Longstaff Radio Service, 808 Buck St., Three Rivers, Mich.

J. A. Strong, USS Dohlin, 3rd Division, San Diego, Calif.
W. I. Hodkin, Box 944, Cristobal, Canal Zone.
Charles R. Grand, 303 E. Porter Ave., Box 411, Chesterton, Ind.
Glenn E. Warren, 11569 Hartsook St., North Hollywood, Calif.
Henry Bal, Box 3, Roseville P. O., Newark, N. J.
Clarence J. Noel, 1356 Worcester St., Inellan Orchard, Mass.
Thomas R. Tuttle, Twisp, Wash.
Joe Soska, 550 Bayway, Elizabeth, N. J.
I. W. Rykert, 6 Fairmount Ave., Batavia, N. Y.
David Blair, 1019 Ave. C, North, Saskatoon, Sask., Canada.
Robert Lockwood, 161 Fairview Ave., Port Chester, N. Y.
Hermann Bublitz, Denville, N. J.
Leonard Weinberg, 316 W. Union St., Jacksonville, Fla.
Alva H. Clark, 806 Main St., Tarboro, N. C.
Paul Lawrence, Swannansa, N. C.
H. A. Daniels, 1705 S. E. 56 Ave., Portland, Ore.

The following letter is an excellent example of those submitted.

(Continued on page 250)

RADIO-CRAFT receives hundreds of magazines from all parts of the world. Since the cost of subscribing to each of these would be prohibitive for most radio men, we have arranged with technical translators to prepare reviews for our readers.

A READY-MADE SERVICE SHOP

ONE of the outstanding items in the magazines received this month, from the stand-point of the Service Man appeared in *The Broadcaster and Wireless Retailer*—a magazine printed for dealers and other members of the "trade."

This item consists of a description of a line of equipment for the service shop which is designed to produce the greatest possible efficiency. As shown in Fig. A, it comprises a workbench large enough for two workers, a phonograph turntable and automatic record changer, an adjustment stand, a parts cabinet, a file cabinet and a set of storage shelves.

The workbench equipment includes servicing equipment, such as an oscillator, analyzer and tube checker.

The dealer or Service Man who is preparing to set up a service shop will undoubtedly find points of interest in the layout and equipment shown in the photo.

POLICE-TYPE POCKET SET

THE development of police pocket receivers has been the subject of much work in England, where they are being used extensively by patrolmen on duty.

The set shown in Figs. B and 1 is a super-regenerative type which is used by the Brighton (England) police. It was described recently in *Wireless World*.

The receiver is 6x4x1 in. in size, the loop aerial being wound around the sides of the box. This loop which contains about 8 turns is connected in series with a coil L1 and coupled to coil L2 to produce regeneration. Coil L1 contains somewhat less turns than it normally would to cover the desired waveband, due to the inductance of the loop.

The resistance R is used to stabilize the circuit and it is important to use this resistor as otherwise oscillation is practically uncontrollable.

The coils L3 and L4 which supply the suppression frequency oscillation may be made by winding 4,000 turns of 38 enamel wire for L3 and 3,500 turns of

the same wire for L4 in a slotted form 1½ ins. in diameter having slots ⅜-in. wide and a space of ⅛-in. between slots.

The values of the other parts are indicated on the diagram. In making a tiny set of the type shown, miniature tubes and other components are a necessity. By careful choice of the coils, condensers, etc., quite a small set can be constructed even when using standard-size 2 V. tubes.

AN ITALIAN ANALYZER-TUBE TESTER

AN INTERESTING set analyzer made by an Italian company and advertised in *La Radio per Tutti* recently offers a contrast to the testing units made in the U.S.

This analyzer, shown in Fig. C, is equipped to test tubes of both the American and European types—and for this purpose contains a multiplicity of composite sockets.

The meter unit used has a 250 micro-ampere movement, supplying a resistance of 4,000 ohms per volt on the D.C. ranges. The voltage readings of the instrument run up to 1,000 A.C. or D.C. The current scales run up to 5A; the ohmmeter reads from 3 ohms to 3 megs.; the capacity meter from 10 mmf. to 18 mf.!

The simplicity of the controls is evident from the photo. It is also gratifying to note the large, easy-to-read meter scale which has a mirror reflector to facilitate taking readings.

CONSTANT REGENERATION

THE designers of regenerative sets, especially for short waves have been trying for a long time to develop circuits which go into oscillation at the same point on the regeneration control, regardless of frequency.

As anyone knows who has operated a regenerative receiver, the regeneration control must be continually manipulated to keep the set at the point just before oscillation starts, where the greatest sensitivity occurs.

(Continued on page 254)

INTERNATIONAL RADIO REVIEW



Fig. B
The appearance of the pocket super-regenerator.

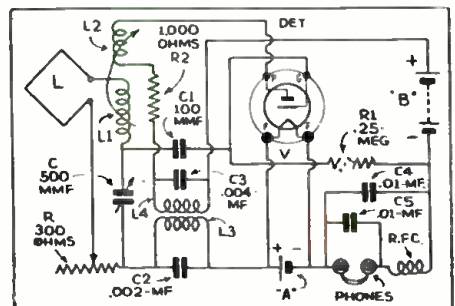

Fig. 1
The circuit of the pocket set for police use.



Fig. C
An Italian analyzer which is quite versatile.

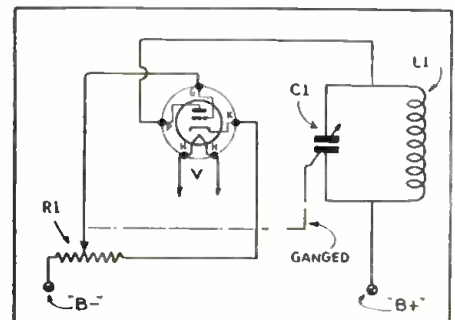

Fig. 2
One way of producing constant regeneration.



Fig. A, left. An interesting service shop set up as a model for Service Men to follow. The equipment used is all made by an English company.

Fig. D, right. A new phonograph recorder for cellulose records. This is a professional unit.



SHORT-CUTS IN RADIO

FIRST PRIZE.....\$10.00
 SECOND PRIZE.....5.00
 THIRD PRIZE.....5.00
 Honorable Mention

EXPERIMENTERS: Three cash prizes will be awarded for time- and money-saving ideas. Honorable mention will be given for all other published items. Send in your best "kinks"!

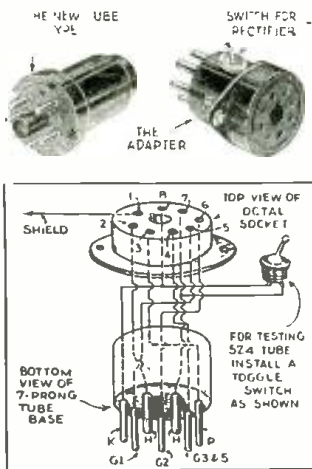

Fig. 1. Metal-tube adapter.

FIRST PRIZE—\$10.00
METAL-TUBE ADAPTER. Now that these tubes are generally available, an adapter will be necessary for test purposes. The simple one shown is made of an "instrument"-type 8-prong socket fastened to a 7-prong socket by means of small brass angles (as the picture shows). Before fastening together, the wiring must be installed and the S.P.-S.T. toggle switch fastened in place. The wiring is done with flexible wire, each piece being about 3 ins. long. All connections may then be made to the socket and switch, the ends being threaded through the pins of the tube base. The shield pin may be left open. The two parts are bolted together, and the leads soldered to prongs Nos. 2 and 8. (Fig. 1)

PAUL K. HARLAN

(As we go to press our attention has been called to the fact that the type 6F5 tube necessitates the use of a second snap switch to swing the octal socket plate connection from terminal 3 to terminal 4.—*Editor.*)

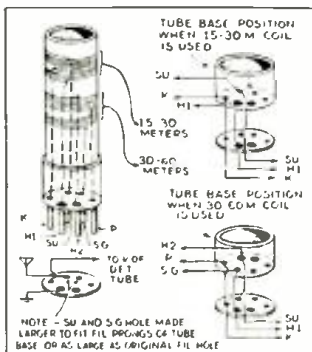

Fig. 2. Compact plug-in coils.

SECOND PRIZE—\$5.00
PLUG-IN COIL HINT. Plug-in coils are a nuisance, especially when used with a portable set. The form shown in Fig. 2 can be made from a tube base and a piece of insulating tubing, or may be an ordinary 6-prong commercial coil form. The windings for any two bands are put in place and wired up as shown. The socket has only three connections to it, and the suppressor- and screen-grid holes are made large enough to fit the filament prongs of the coils, so that when the latter are reversed, another set of windings is connected to the three prongs of the socket. (The coils shown are for use with a detector, a cathode tap being employed for regeneration.)

TRANQUILINO M. NAVARRO

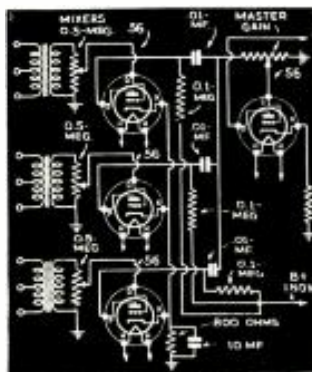

Fig. 3. Above, low-cost mixer.

THIRD PRIZE—\$5.00
LOW-COST MIXER. By this means, several sources of input may be mixed and any may be varied without disturbing the others. Ordinary 0.5-meg. potentiometers are used for the individual volume controls. The cost of the extra tubes and associated equipment is less than that of the expensive, constant-impedance type mixers that are ordinarily used. (Fig. 3.)

CHARLES M. DIBRELL

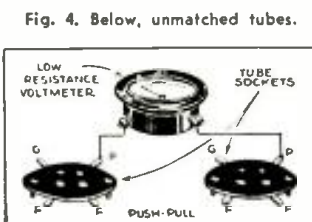

Fig. 4. Below, unmatched tubes.

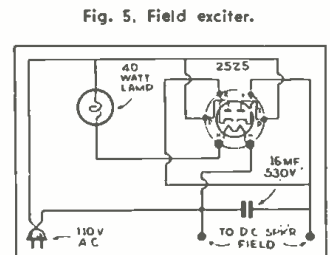

Fig. 5. Field exciter.

HONORABLE MENTION
DETECTING UNMATCHED TUBES. Push-pull tubes must be matched, in order to obtain good quality, lack of hum, and plenty of pep. A perfect match will be shown by zero reading when the voltmeter is connected between the plate prongs of the output tubes. If meter reads backwards, reverse the connections. A reading of more than one volt indicates that a new tube should be put in. (Fig. 4.)
 ERNEST J. CHRISTIANS

HONORABLE MENTION
SIMPLE FIELD EXCITER. This exciter costs almost nothing to build and is an extremely handy unit to have at hand. The output voltage under load of about 80 ma. will be around 145 V. Only a 40 W. lamp should be used, as this provides the correct voltage drop for the filament of the 25Z5 rectifier. (Fig. 5.)
 H. P. KELLY

HONORABLE MENTION
PRONG EXTENSIONS. In some ultramidget sets the rectifier tube and the one adjoining it are placed in sockets almost touching, so the prong extensions shown were made to extend the adapter plug to test in these sockets. The sleeve may be made from sheet metal wrapped around a 10-penny nail or from tubing. The prongs from the bottom are cut from an old tube and soldered in place. (Fig. 6.)
 HARRY F. SLICK, JR.

HONORABLE MENTION
ADDING A TWEETER. This high-frequency speaker can be used with any set to increase the high-frequency response. It is simply a single headphone of any standard make, with a microphone mouth-piece cemented to the cap. This unit may be used with single-ended or push-pull output stages. (Fig. 7.)
 H. PUTNAM

HONORABLE MENTION
PANEL MARKINGS. A professional touch can be given to home-made apparatus by marking the panel with "engraving" made as shown. The words desired are typed out on paper and then cut out to fit the

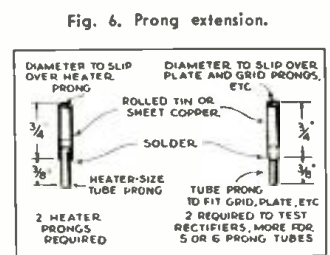

Fig. 6. Prong extension.

The holes must be drilled to the proper diameter to fit the words used and they should be kept as near one size as possible. After the cutouts are glued in place, they are painted with red fingernail polish. A wool bit should be used on wood to insure a clean hole. (Fig. 8.)
 W. E. ROBBINS.

HONORABLE MENTION
EFFICIENT COIL FORMS. While experimenting with a short-wave set, it was found that the circuit (Continued on page 244)

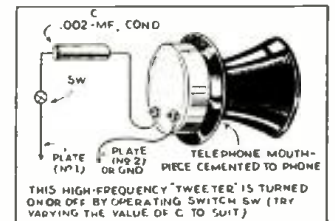

Fig. 7. Adding "tweeter" speaker.

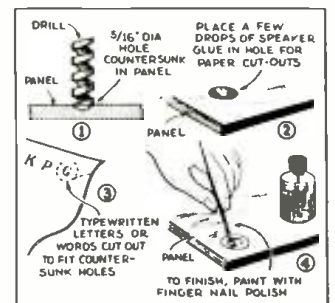

Fig. 8. Marking panels.

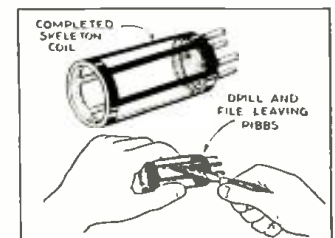

Fig. 9, above. Low-loss coil forms.

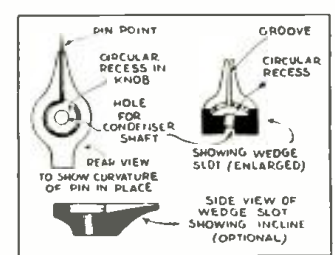

Fig. 10, below. Pointer knob.

THE LISTENING POST FOR ALL-WAVE DX-ERS

C. A. MORRISON



Station XGOA, the 75 kw. broadcast station at Nanking, China—the largest in China.

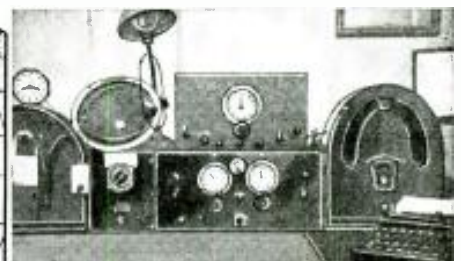
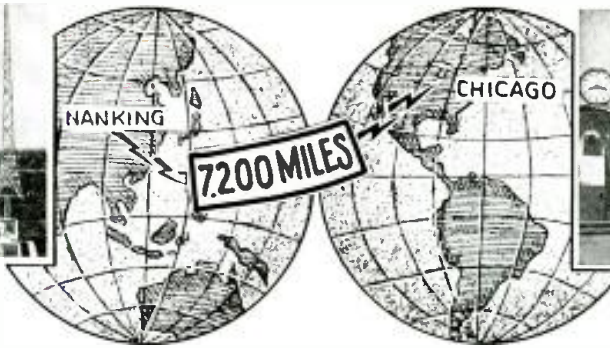

The listening post of Robert L. Weber in Chicago, Ill., where XGOA was heard.

EAST IS East and West is West, and ne'er the twain shall meet." This famous assertion by Rudyard Kipling can no longer be said to hold absolutely true, for we have at last found a meeting place—thanks to the universal influence of radio in recognizing neither national boundaries, racial prejudices, nor political distinctions.

With equal ease the experienced dial twirler can capture the living statements of Mussolini, King George, or President Roosevelt—with equal ease capture the throbbing beat of the Argentine tango, the haunting hula melodies of Hawaii, or the lovely waltz classics as they can be played only in Germany. The treasures of the world's music, drama, and oratory are poured out daily for the enjoyment and entertainment of the DX-er.

"DX" is the pass-word to this realm of fascination. For it is through "DX-ing" or the pursuit of far-distant stations that this treasure house is opened for you. Truly, DX is a modern "sesame" more wonderful and far more potent than Aladdin's lamp!

From Capetown, South Africa, to Reykjavik, Iceland, or from Shanghai, China, to London, England, the DX traveler is transported in the twinkling of an eye. Is this not more miraculous than the fabled "Magic Carpet"?

DX is not limited to any certain age, occupation, or social class. DX claims its adherents from the youngest to the oldest, from the mightiest potentates to the humblest laborers.

To those of you who have not as yet succumbed to the daily thrills of DX-ing, let us urge you to purchase an all-wave receiver, equip yourself with a note book, pencil and good log book, settle down in your easy chair, climb aboard the good ship DX, and come for a sail with us to lands that heretofore have existed for you only in the musty pages of a forgotten atlas. We venture to predict, that if entered wholeheartedly this sport will bring you more real enjoyment, more entertainment, and relaxation from the cares of the day than anything you have done previously. *LET'S DX!*

THE BROADCAST BAND SEPT.-OCT.

Although foreign broadcast-band DX in general can not be said to be at its peak during these early Fall months, there is one type of B.-C.B. DX which is at its peak during September and October. This is reception from the Antipodes, or "Down and Under," as we say when referring to Australia and New Zealand. These countries are just going into Spring, as we go into our Fall, and with both the Southern and Northern hemispheres enjoying the same climatic conditions the reception path across the broad Pacific Ocean from this direction is at its best.

You must be an early riser to tune in these stations, as they are at their height around 4:00 a.m. to daylight, E.S.T. It must be remembered in tuning in these Trans-Pacific stations that they will not come in with the

pep of an ordinary U.S. DX catch. Conditions must be just right and then you must exercise a great deal of patience and care in tuning.

Tune your broadcast-band dial with the same care that you use in tuning on the short-waves (say on the crowded 49 meter band) when you are trying to separate closely-crowded channels and you will be tuning about right. Starting at the low-frequency end of the dial where WIND, Gary, Indiana, comes in on 560kc. listen for the carrier wave of 6WA, Minding, West., Australia. You may have to leave your dial setting on the channel for some two, or three minutes before a sound is heard, as these Australasian stations have a tendency to fade badly, and you have to catch them on their greatest volume surge.

Soon you may hear a very faint swish as you turn back and forth, and by straining your ears you will hear singing, or talking, 'way, 'way back in the background. Gradually this sound will become more pronounced, and you will catch a word now and then. Every identifiable word should be jotted down for verification purposes. The station is about to reach its peak volume now, and on good nights will

(Continued on page 252)



The photo at the left shows part of the aerial and the transmitter building of the broadcast station at Helsinki, Finland. Right, the aerial and counterpoise system for the broadcast transmitter at Bisamberg, near Vienna, Austria. The tower is 400 ft. high.



ANALYSES of RADIO RECEIVER SYMPTOMS OPERATING NOTES

RCA VICTOR, MODEL 119

WHEN new, set worked fine. After about a month of service, only locals could be received. Upon a thorough check of the entire set, all parts seemed OK but the R.F. stage trimmer seemed too broad in tuning. An ohmmeter check showed a resistance of about 3,000 ohms to ground, which was far too low, as the secondary is in the A.V.C. circuit. The variable condenser was found to be faulty, the insulation having apparently absorbed moisture, as may be seen in Fig. 1. A thorough drying and coat of paraffine cured the trouble. A trace of acid probably got on the bakelite.

O. B. RUDOLPH

MAJESTIC 460

THIS set came in with a howl and no reception. A close check of the resistors showed the leak from grid number 1 of the 2A7 to the cathode was about double the value it should be. This threw the set entirely out of balance. Fig. 2 shows the affected circuit.

Another common trouble in this set is open plate windings in the 2nd I.F. coil, and this should always be checked.

J. D. BUIE

CANADIAN NOTES

THE following notes are of special interest to Canadian Radio Service Men. Let's see more "Notes" as good as those submitted (in excellent shape) by Mr. Welsh.—*Editor*

NORTHERN ELECTRIC 101 AND 81

THESE all-wave receivers often give very poor operation on the short-wave bands, particularly on the very high

THE PURPOSE OF THIS DEPARTMENT

It is conducted especially for the professional Service Man. In it will be found the most unusual troubles encountered in radio service work, written in a practical manner, by Service Men for you.

Have you, as a professional man, encountered any unusual or interesting Service Kinks that may help your fellow workers? If so, let us have them. They will be paid for, upon publication, at regular space rates.

frequency (blue) band, even after they have been carefully aligned with an all-wave oscillator. The modification I have used with success is shown in Fig. 3A and consists, briefly, in supplementing the electro-magnetic coupling between the preselector coils by capacitive coupling through the added condenser Cx, .005 mf. capacity. The improvement in sensitivity once this modification is made and the receiver re-aligned, is amazing, and, in the Model 101 can be increased still more by reducing the bias on the third I.F. tube. However, if the bias is reduced too much, the background noise will become excessive.

The .005 mf. condenser is not in circuit when the broadcast band is in use, and cannot, therefore, impair the set's selectivity on this band.

The Model 81 receiver is also troubled with very broad tuning. To correct this trouble, it is necessary to replace the first and second I.F. trans-

formers, which are incorrectly designed.

DEFOREST CROSLY ARIA-TROUBADOUR (8 tube) and MELODY (9 tube)

ALL of these models come in sooner or later with the complaint of distortion, or very low volume, or both. This is caused by the breaking down of a 20,000 ohm 2 watt carbon bleeder resistor from the R.F. plate supply to the cathode of the audio tube, to be seen by referring to Fig. 3B. (In the case of the Melody, the cathode of the second A.F. tube). It breaks down to such a low resistance that the A.F. tube is very much over-biased, causing the above complaints. The best remedy is to do away with the bleeder and self-bias the tube with a 2,000 ohm, 1 watt, carbon resistor.

The Aria-Troubadour models use a Peerless speaker with a single-turn aluminum voice coil bolted directly to the thick copper band which forms the secondary of the output transformer. Loose or imperfect connection at this point results in "thin" tone. The Magnavox speaker in the 9 tube model gives trouble with an open field coil. The wire corrodes where it is soldered to the thicker lead wire leading to the terminal board. The trouble is easily repaired and a new coil is not usually necessary.

The 8 tube chassis uses 3-24, 2-27, 2-45, and 1-80 tubes; the 9 tube chassis uses 3-24, 3-27, 2-45, and 1-80 tubes.

VICTOR R6

THE faulty operation of the Victor R6 can often be traced to the 8,000 ohm cathode resistor. This is over-

(Continued on page 254)

Fig. 1, below. Trouble in RCA Model 119.

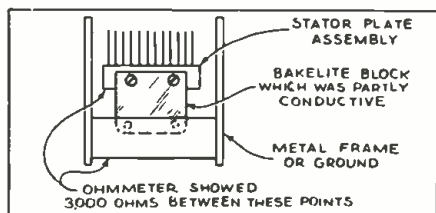

Fig. 2. Repairing the Majestic model 460.

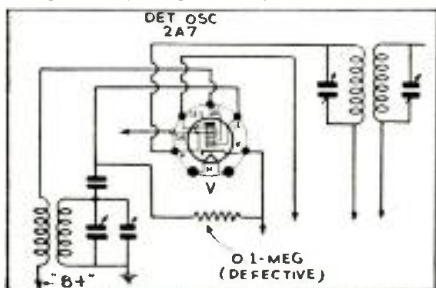
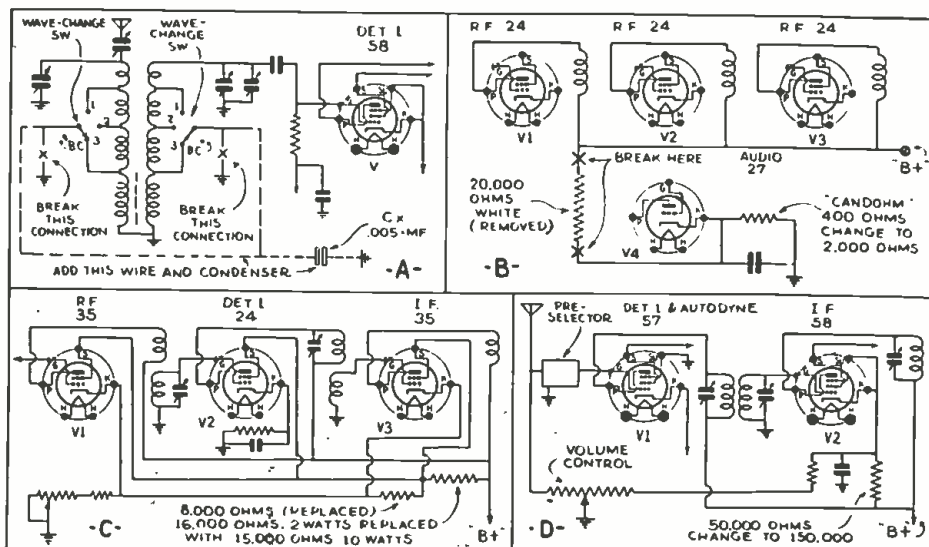

Fig. 3, below. The following service notes are of special interest to Canadian Service Men.





PORTABLE CONDENSER TESTER

RADIO-CRAFT, ORSMA Dept.:

Here is a portable condenser tester that can be built very cheaply, requires only a small amount of space, and can also be used as an emergency source of power.

This tester can be made either with, or without a milliammeter, and can be used on A.C. or D.C., 110 or 220 V., an extra "cordohm" being used for 220 volts.

The variable bleeder is an old Clorostat, taken from a Majestic "Super-B," and is used to regulate current and voltage as desired.

The usual routine of condenser testing is followed: a good condenser will flash the neon tube once; if the condenser is open, there will be no flash; if O.K., the bulb will flash on and off, the rapidity of the flashes showing the amount of leakage.

The diagram of Fig. 1 is for a half-wave rectifier, but Fig. 2 shows how to use the 25Z5 as a full-wave rectifier. In either case the power supply connects to the tester at terminals 1 and 2.

The 25Z5 tube is well recognized and I am surprised it has not been put to use sooner. I have been using this outfit for a considerable length of time, and wish to pass it on to my fellow Service Men, as I know they will appreciate it.

GEORGE F. BAPTISTE,
Howard, R. I.

Mr. Baptiste, who has become almost a regular contributor, shows us how to build a simple, light-weight power supply, and condenser tester. By taking off taps at the proper places, the power supply can be used for a speaker-field supply, for high-resistance measurement, and many other uses that will occur to the resourceful Service Man.

BEATING "POOR BUSINESS"!

RADIO-CRAFT, ORSMA Dept.:

Enclosed you will find some advertising ideas that I have used with very good results.

Last year about this time I had very little to do, and something had to be done to get some work; "advertise, that's it," but it must be an advertise-

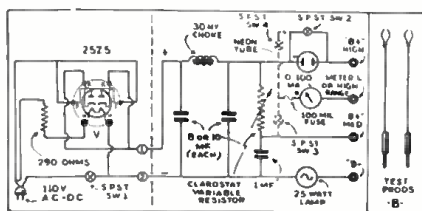
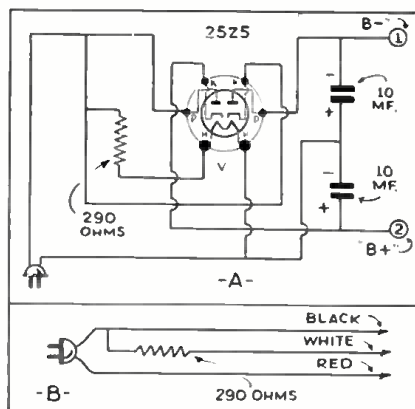
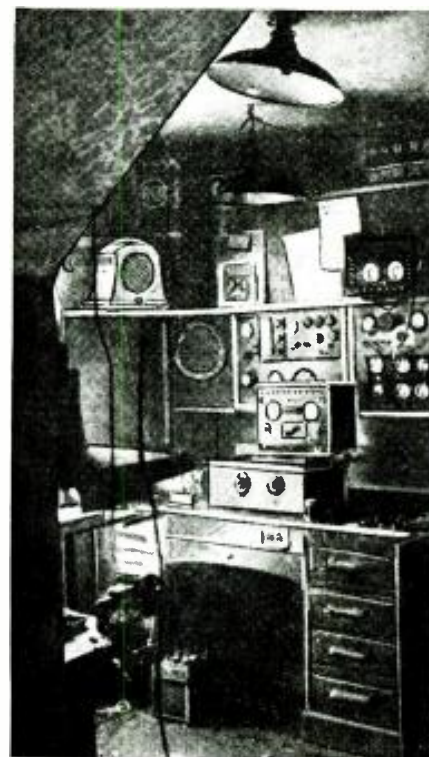

Fig. 1, above. A complete light-weight condenser tester, with half-wave rectifier. Fig. 2, below. The connections for use of a full-wave rectifier. Right, Mr. Corideo's service shop.



ment that would attract the attention of the public. Well, after looking through the advertisement hints in *Radio-Craft*, I finally made up a circular, one of which I have enclosed. I had 10,000 of these printed and distributed around the city. The returns were so good that I had 10,000 more printed, and thrown around the town. I had all the work I could handle; I was getting \$1.50 for a service charge last year; this year I charge \$1.00 and I get it (so far there is no depression with me), and there are a few up here who advertise "Free Service."



This year I had 10,000 radio logs printed. I hired two young high school boys to go around distributing them; these were not thrown around like the circulars, but handed to the person answering the door.

After ringing the bell, the party comes to the door, and you greet her with "Good morning [or afternoon]. We are giving away free radio logs to those who own radios. Do you own a radio? What make is it? How long have you had it? Is it giving you satisfactory service?" etc.; so when I am

(Continued on page 255)

Below, Mr. Corideo's filing system, where he keeps all items of interest or particular value.

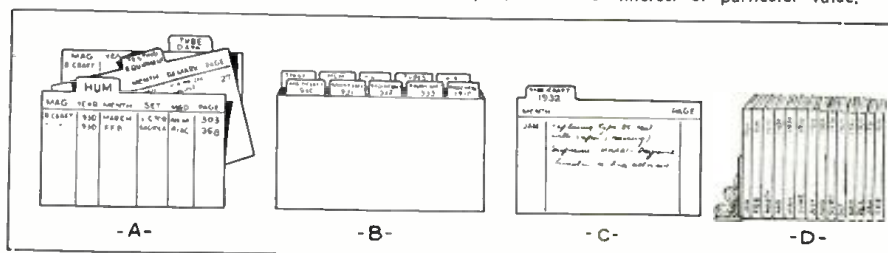

SPECIAL NOTICE

Those questions which are found to represent the greatest general interest will be published here, to the extent that space permits. (At least 5 weeks must elapse between the receipt of a question and the appearance of its answer here.) Mark such inquiries, "For Publication."

Replies, magazines, etc., cannot be sent C.O.D. Back issues of **RADIO-CRAFT** prior to December, 1932, are available at 50c per copy; except the following issues: 7/29, 1, 2, 3, 4, 6, 7, 9 and 11/30; 5, 8 and 9/31; and 7/33, which are out of print. Succeeding issues are still available at the regular price of 25c per copy.

Inquiries to be answered by mail **MUST** be accompanied by 25c (stamps) for each separate question; answers are subject to subsequent publication if considered of exceptional interest.

Furnish sufficient information (in reference to magazine articles, be sure to mention issue, page, title, author and figure numbers), and draw a careful diagram (on separate paper) when needed to explain your meaning; use only one side of the paper. List each question. Be **SURE** to sign your name AND address.

Enclose only a **STAMPED** and self-addressed envelope for names and addresses of manufacturers; or, in connection with correspondence concerning corrections to articles, as this information is gratis.

Individual designs can be furnished at an additional service charge. The fee may be secured by addressing the inquiry to the **SPECIAL SERVICE** department, and furnishing **COMPLETE** specifications of desired information and available data.

RADIO-CRAFT'S INFORMATION BUREAU

THEREMIN COILS

(341) Mr. Roy Alexander, Montezuma, Ia. (Q.) In *Radio-Craft*, April 1935, page 600, it tells how to build an easily-made Theremin. I have not been able to get the Renier type 620 oscillator coils. However, I have on hand two RCA 80 coils. How much change is necessary to use these coils?

(A.) The RCA 80 coils may be used after a slight change is made, according to an answer in this connection recently received from Mr. Deeter, the author. Referring to the wiring diagram of the RCA 80, we find the oscillator coil drawn as in Fig. Q.341A. Break the grid coil winding at X, unwind an eighth of an inch in each direction and run leads to terminals, as 3 and 6 in Fig. Q.341B. The plate coil, B in Fig. Q.341 A, will be used for the pick-up and mixing coil in the new arrangement. Starting from the end farthest from the grid and plate coils (A), unwind wire from coil B until only 10 turns remain, and then take off leads. The section of A that is next to coil B will constitute the plate coil of the oscillator circuit.

The numbers shown in Fig. Q.341B are equivalent to the numbers appearing in the *Radio-Craft* diagrams, and by following these the hook-up will be correct.

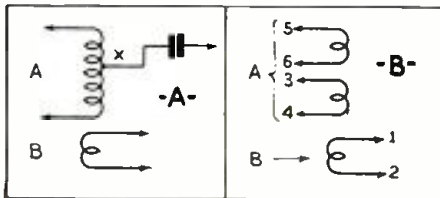

Fig. Q.341, above. Theremin coils.

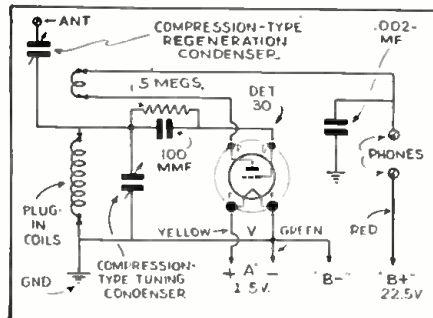
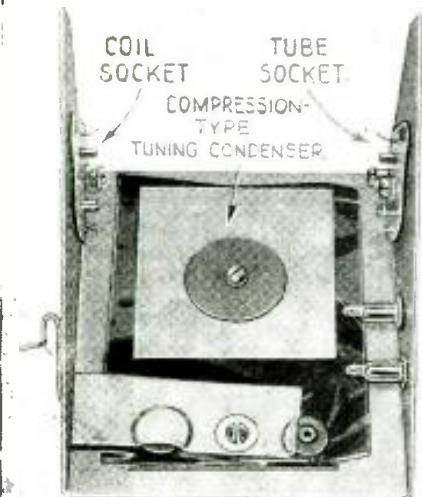

Fig. Q.342A, above. Diagram of Chum set.

Fig. Q.342B, below. Underside view.



BEGINNER'S SET

(342) Jack Dindrow, Baxters Lake, Idaho. (Q.) I am just a beginner in radio, and would like to get a picture and diagram of a very simple set. I do not want a crystal set, so please show me one with 1 tube, for battery operation.

(A.) Such a set as you wish is diagrammed in Fig. Q.342A. This set uses the simplest circuit possible and the battery drain is very low. Plug-in coils are used, so that any wave-band can be worked on. An underside view is depicted at Fig. Q.342B, showing all the units mounted and ready for wiring. The kit for this battery set can be purchased at a very reasonable price.

ADDING A "TWEETER"

(343) Mr. J. M. Warren, Rockland, Ohio. (Q.) My broadcast receiver is supposed to afford "high-fidelity" reproduction. At present I am using only one loudspeaker, a 12 in. dynamic. How can I add a high-frequency type speaker to this outfit, so that the response will be broader than at present, and the highs can be increased or decreased at will? Please give diagram.

(A.) A crystal-type speaker will be the most practical in your case, since it's use will not disturb the impedance match between power tubes and transformer. Fig. Q.343 shows how this is done. This circuit is applicable to both single and push-pull output systems. In the former instance, condenser C2 would not be required, the "tweeter" and low-voltage side of variable resistor R re-

(Continued on page 254)

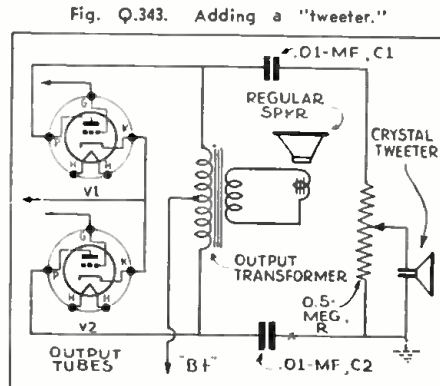

Fig. Q.343. Adding a "tweeter."

P.A. QUESTIONS & ANSWERS

Conducted by
CHARLES R. SHAW

Here is a new department for the Radio Dealer, Service Man and Sound Technician who require general information and help in P.A. work. This department will furnish valuable aid for the asking. Address all questions to *Radio-Craft's* Public Address Forum. Only those questions of general interest will be published and we reserve the right to publish any of these inquiries and answers.

"OPTICAL SYSTEM" ADJUSTMENT

(16) Mr. A. Lewis, Niagara Falls, N. Y.

(Q.) What is the best procedure to follow in adjusting the optical system of standard projector sound mechanisms?

(A.) The best method for adjustment of sound heads varies with the type of projector employed. Generally, the following procedure will be found satisfactory:

Place a piece of black film through the sound gate and close the gate. Then focus the lens barrel by lighting the exciter lamp and moving the lens up and down until a sharp, wide beam of light appears upon the film. This can be viewed through the photoelectric cell housing by first removing the cell. Rotate the lens barrel to right or left until the light beam is exactly at right angles to the slot in the P.E. cell housing. Tighten the lens barrel at this point. It is, of course, necessary to check the adjustment by running a film through the sound mechanism so that minor adjustments can be made for best results by checking against the actual reproduction.

INDUCED HUM

(17) Mr. George Carter, London, England.

(Q.) Will an unshielded speaker transmission line 3,000 ft. long pick up A.C. hum if run parallel to a 110 V. A.C. power line?

(A.) Yes, if the transmission line is not twisted or if both lines are very close together. By using a twisted line and keeping the line 3 ft. from the power line, the induced hum will be inaudible.

SPEAKER VOLUME CONTROL

(18) Mr. M. M. Richardson, Dayton, Ohio.

(Q.) What is the best method for individually controlling the volume of 8 similar speakers (15 ohms each voice-coil) remotely placed from the amplifier?

(A.) (See Fig. Q.18) Use separate 200-ohm line to eight 15-ohm voice coil transformers, with a 200-ohm "L" pad across the primary of each line transformer. With the speakers arranged in series-parallel they may be connected to a

(Continued on page 255)

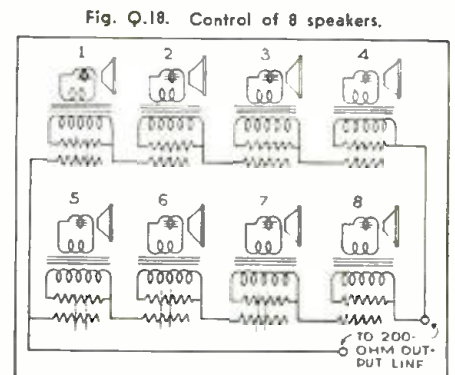

Fig. Q.18. Control of 8 speakers.

THE FIRST 10 METAL TUBES



CHARACTERISTICS OF METAL TUBES
-AND OTHER "OCTAL" (8-PRONG)-BASE TYPES

TUBE TYPE	Fil. or Heater		Max. Pl. V.	Max. S.G. V.	Grid Neg.	Pl. Ma.	Cath. Ma.	Plate Resis.	Mutual Cond.	Amp. Factor	Plate Load	Out-Put Watts*	Equiv. Types	No. of Pins	Function
	V.	A.													
6A8 RK	6.3	0.3	250	100	3.0	4.0	14	300M	520	6A7	8	Pent. Converter
6A8 A	6.3	0.3	250	100	3.0	2.6	12.8	6A7	8	Pent. Converter
6A8 TNS	6.3	0.3	250	100	3.0	3.5	...	360M	6A7	7	Pent. Converter
6C5 RATNKS	6.3	0.3	250	...	8.0	8.0	...	10M	2,000	20	76	6	Triode Amply.
6D5 RATNKS	6.3	0.7	275	...	40	31	...	2,250	2,100	4.7	7,200	1.4	45	6	Triode Amp., Class A
6D5 NKA	6.3	0.7	300	...	50	23	5,300	5.0	45	6	Triode Amp., Class AB
6F6 RKS	6.3	0.7	250	250	16.5	34	...	100M	2,300	200	7,000	3.0	42	7	Pentode Output, Class A
6F6 T.N.	6.3	0.7	250	250	16.5	34	10.5	100M	2,200	220	7,000	3.0	42	7	Pentode Output, Class A
6F6 KS	6.3	0.7	250	...	20.0	31	31	2,600	2,700	7.0	4,000	.85	42	7	Triode Output, Class A
6F6 K	6.3	0.7	250	250	26.0	17	19.5	10,000	19.0	42	7	Pentode Output, Class AB
6F6 K	6.3	0.7	350	...	38.0	22.5	6,000	18.0	42	7	Triode Output, Class AB
6H6 RATNKS	6.3	0.3	100	Direct Current 2 Ma. (max)				...	1,225	1,500	+	...	none	7	Duodiode Detector
6J7 RTKANS	6.3	0.3	250	100	3.0	2.0	2.5	1.5 meg. +	1,225	1,500	+	...	6C6	7	Pentode Det.-Amp. (Non-var. Mu.)
6K7 RTANKS	6.3	0.3	250	100	3.0	7.0	8.7	800M	1,450	1,160	6D6	7	Var. Mu. Amplifier
6L7 RNKA	6.3	0.3	250	150	6.0	3.5	...	2.0 meg. +	325	none	7	Pentagrid Mixer-Amplifier
6L7-G A	6.3	0.3	250	100	3.0	5.3	...	800M	1,100	none	7	Pentagrid Mixer-Amplifier
5Z4 RKNTS	5.0	2.0	400	Max				125	5Z3	5	Full-wave—H.V. Amplifier
6P7 A (Pent. section)	6.3	0.3	250	100	3.0	6.5	8.0	850M	1,100	900	6F7	8	Pentode and
(Triode sections)	100	...	3.0	3.5	3.5	17,800	450	8	6F7	8	Triode Amp. in one Bulb
43-MG T	25.0	0.3	135	135	20	34	41	35,000	2,300	80	4,000	2.0	43	7	AC-DC Power Amp. Pentode
6B6	6.3	0.3	250	...	2.0	0.8	...	91,000	1,100	100	75	7	Duodiode-Triode
6F5 NATKS	6.3	0.3	250	...	2.0	0.9	0.9	66,000	1,500	100	none	5	High-Mu. Triode
25Z5-MG T	25.0	0.3	125	100	25Z5	7	Full-Wave Rectifier
5Y3 A	5.0	2.0	400	125	80	5	Full-Wave Rectifier
50A2-MG T	50 V. total drop; 0.3-A.:												none	4	Ballast tube
50B2-MG T	50 V. total drop; 0.3-A.:												none	4	Ballast tube

R-RC-A and Ray heon; K-Ken-Rad; A-Arcurus; T-Triad; N-National Union; S-Sylvania. These letters appearing after the tube types above mean that data was available from the makers on these particular types. Some manufacturers do not as yet make all the types at present available. Arcurus tube designations are all terminated by "G," meaning glass-metal; the Triad termination is "MG," meaning metal-glass. Where manufacturers differ somewhat in their tube characteristics, the tube is listed twice, as is the case with the 6A8. The power tubes, 6D5 and 6F6 appear more than

once because they are used under different operating conditions. The 6H6 is equivalent to the two diodes of a 75, while the 6F5 resembles the triode section of a 75. The Triad 50A2-MG and 50B2-MG are ballast tubes, both having a voltage drop of 50, the former for use with one Type No. 40 pilot lamp and the latter for use with two. They are to be used in A.C.-D.C. sets, in place of the usual series resistors. The 6L7 is an entirely new type and is described in detail elsewhere in this issue. *Undistorted.

RMA STANDARD METAL TUBE BASING (BOTTOM VIEW)

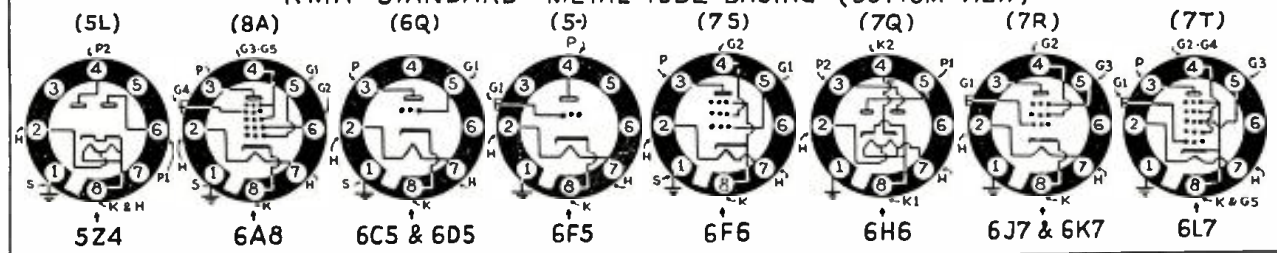

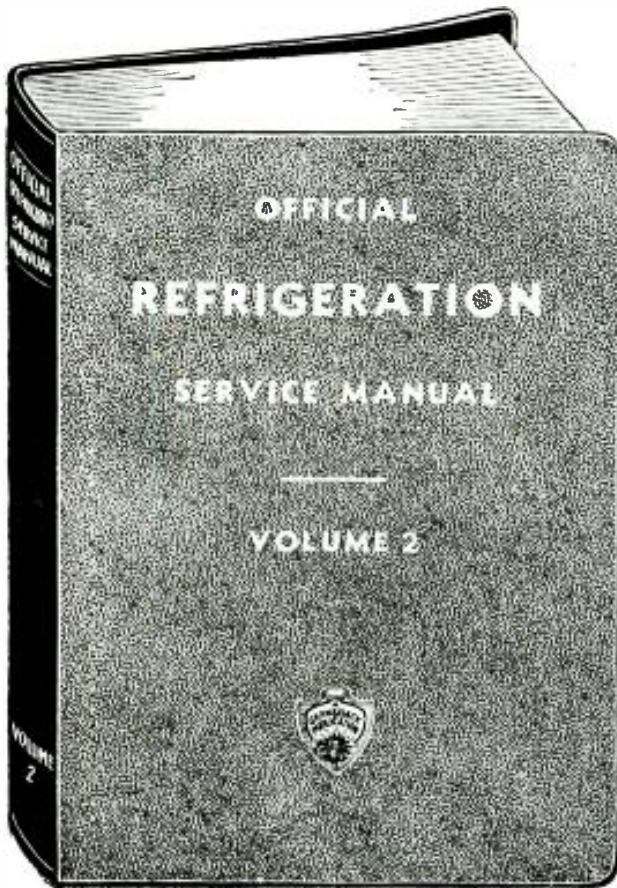

**THIS IS THE ONLY COMPLETE
REFRIGERATION SERVICE MANUAL
EVER PUBLISHED - - -**

*Entirely New Material
from Cover to Cover!*

Announcing—

Volume Two

OF THE *Official* REFRIGERATION SERVICE MANUAL

OVER 350 PAGES
OVER 300 DIAGRAMS

Flexible, Looseleaf Binder
Complete Service Data

This New Refrigeration Manual is printed on a special Bible stock. This stock, although unusually thin, is exceptionally strong and durable. It makes handling of the book much easier.

Price **\$5.00**
NET

**CLIP—
MAIL
COUPON
TODAY!**

The new volume of the OFFICIAL REFRIGERATION SERVICE MANUAL (Volume II) contains specific service data and information of value to everyone interested in refrigeration.

This Manual forms a companion and supplement to the previous OFFICIAL REFRIGERATION SERVICE MANUAL (Volume I), since all data in the 1935 volume is entirely new.

The OFFICIAL REFRIGERATION SERVICE MANUAL was the first refrigeration Service Manual ever published—and now this new volume has been prepared so that they both form a comprehensive library of information on this rapidly growing refrigeration industry.

The curve of sales of refrigerators and replacement parts has steadily increased year by year—even during depression years. It is the one industry to make this progress. Year by year sales increases will soon place Refrigeration in rank with the automobile industry in importance.

Detailed information on servicing; outlines of theory and methods of operation; instructions for the handling of refrigerants; charging systems; diagnostic troubles; trouble charts; electrical hook-ups; charges of oil and refrigerant in different models; advice on the selection of oils; placement and temperature required by foods; valve settings; compressor construction, faults, overhauling; estimating coil and machine loads; are encompassed in this new volume of refrigeration servicing.

List of Contents in the Second Volume of the "Official Refrigeration Service Manual"

History	Commercial Unit Specifications and Service
Food Preservation	Household Unit Specifications and Service
Theory and Fundamental Laws	Servicing Refrigeration Apparatus; general
Methods of Refrigeration	Servicing Low Side Float Valve Systems
Refrigerants, Lubricants and Brines	Servicing High Side Float Valve Systems
Handling, Testing and Storage of Refrigerants	Servicing Expansion Valve Systems
Compression System of Refrigeration	Servicing Thermostatic Valve Systems
Liquid Throttle Devices and Valves	Servicing Restrictor and Capillary Tube Systems
Refrigeration Systems	Charging Systems with Refrigerant
Electric Control Devices	Electrical Service; Motors, Fuses, Hookups
Compressors, Types, Seals, Valves, Capacities.	Service Kinks
Service	Estimating Refrigeration Loads, Coil and Machine Sizes
Evaporators and Cooling Units	Miscellaneous Data
Service Tools, Equipment and Tool Manipulation	

GERNSBACK PUBLICATIONS, INC., 99 HUDSON ST., NEW YORK, N.Y.

GERNSBACK PUBLICATIONS, Inc. RC-10-35
99 Hudson Street, New York, N.Y.

Gentlemen:—Enclosed you will find my remittance of \$5.00, for which send me one copy of the OFFICIAL REFRIGERATION SERVICE MANUAL (Volume II). I understand that this book is to be shipped to me POSTAGE PREPAID.

Name _____

Address _____

City _____ State _____

Please Say That You Saw It in RADIO-CRAFT

FADA 9 TUBE MODEL 190 "METAL" ALL-WAVE RECEIVER

(Four bands; covers 540 kc. to 24 mc. with no skips; noise suppression; automatic tone regulator; delayed A.V.C.; push-pull output with 6 watts power; 9 metal tubes; triple tuned I.F. coils.)

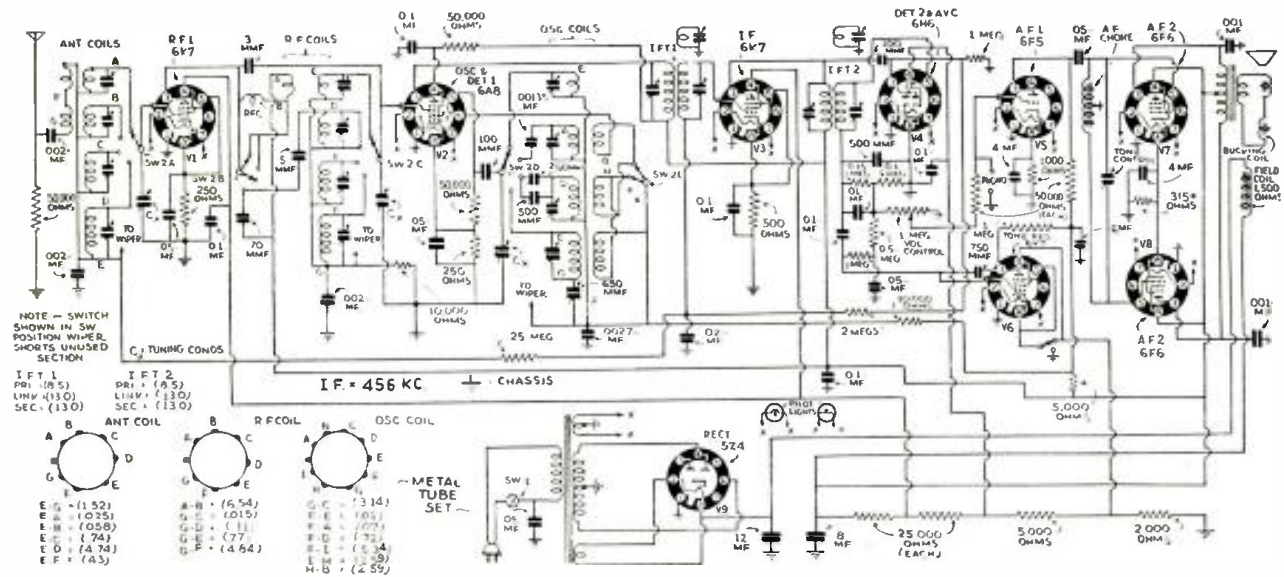

I.F. Adjustments

First, disconnect the outside antenna system from the receiver. Second, disconnect the control-grid lead from the 6A8 tube. Third, connect the high-potential lead of the signal generator to the control-grid of the 6A8 tube, and the low-potential side to the receiver "ground" lead. Fourth, place an output meter (copper-oxide type) across the speaker voice-coil. Fifth, place the signal generator in operation and adjust the carrier output to 456 kc.

Adjustment of S.-W. Band "A" Shunt Condensers

The compensators are located as indicated in the sketch. (A) Remove the signal generator connection from the control-grid of the 6A8 tube and replace the control-grid lead. (B) Connect the antenna wire of the receiver chassis through a 400 ohm carbon resistor to the high-potential side of the signal generator. Adjust the carrier output of the signal generator to 20 mc. (C) Turn the wave-band selector switch to band "A." left. Set the calibrated dial of the receiver to read 20 mc. (D) Adjust the S.-W. band "A" oscillator shunt compensator for maximum signal output. (E) Having determined the peak, and maximum setting for the S.-W. band "A" oscillator shunt compensator, adjust the S.-W. band "A" R.F. stage shunt condenser and the S.W. band "A" detector shunt

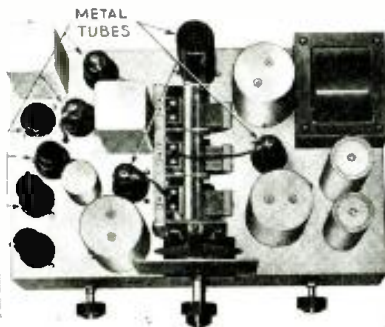

condenser for maximum signal output. Turn the receiver dial to the image point (20.9 mc.) to determine that both condensers have been adjusted to the correct peak. (F) Adjust the carrier frequency output of the signal generator to 10 mc. (G) Turn the calibrated dial of the receiver to pick up this 10 mc. signal and check for sensitivity at this point. There is no variable oscillator series condenser at this frequency.

Adjustment of S.-W. Band "B" Shunt Condensers

First, maintaining the same signal generator output (10 mc.) turn the wave-band selector switch to band "B." Second, follow the immediately preceding paragraph No. C, turning to 10 mc. Third, follow D, but on twin peaks use farthest "out" setting; use 9 mc. image setting. Fourth, follow E, but use 9 mc. image point; refer also to D. Fifth, follow F, at 10 mc. Sixth, follow G, at 10 mc.

Adjustment of S.-W. Band "C" Shunt Condensers

First, adjust the signal generator to 3.75 mc. Second, follow C at 3.75 mc. Third, follow D, but on twin peaks use farthest "out" setting. Image check point is 2.8 mc. Fourth, follow E, use 2.8 image check.

Adjustment of S.-W. Band "C" Oscillator Series Padder

(H) Adjust the carrier frequency output of the signal generator to 1.5 mc. (I) Turn the calibrated dial of the receiver to pick up this 1.5 mc. signal. (J) Adjust the S.-W. band "C" oscillator series trimmer until a maximum output signal is indicated on the output meter. (K) Having determined the maximum peak of the S.-W. band "C" oscillator series trimmer, re-adjust the carrier frequency of the signal generator to 3.75 mc. Turn the calibrated dial of the receiver to 3.75 mc. and re-adjust S.-W. band "C" oscillator shunt condenser, and then, S.-W. band "C" R.F. stage shunt condenser and S.-W. band "C" detector shunt condenser for maximum signal output; checking for image point as outlined in the foregoing instructions.

Adjustment of BC. Band "D" Shunt Condensers

The condensers are located as indicated in the sketch. First, remove the 400 ohm carbon resistor from the high-potential side of the signal generator and insert a 250 mmf. mica condenser in its place. Second, turn the wave-band selector switch to band "D," broadcast position. Third, adjust the carrier frequency of the signal generator to 1,500 kc. Fourth, set the calibrated dial of the receiver to 1,500 kc. Fifth, adjust the BC. band "D" oscillator shunt condenser and then, the BC. band "D" R.F. stage shunt condenser and BC. detector shunt condenser.

Adjustment of BC. Band "D" Oscillator Series Trimmer

First, follow H, set at 600 kc. Second, follow I, but at 600 kc. Third, follow J but adjust the BC. band "D" oscillator series trimmer. Fourth, having determined the maximum peak of the oscillator series trimmer, re-adjust the carrier of the signal generator to 1,500 kc. Turn the calibrated dial to 1,500 kc. and then, re-adjust the BC. band "D" shunt condensers.

Operating voltages are as follows:

Tube Type	Plate Volts	Plate Ma.	Cath. Volts	S.-G. Volts
V1	229	7.8	3	89
V2	229	3.1	3	78
V3	228	5.8	4	88
V4	—	—	17	—
V5	154	.9	1	—
V6	30	.15	—	6
V7	212	22.0	15	217
V8	212	22.0	15	217
V9	—	80.0 Total	—	—

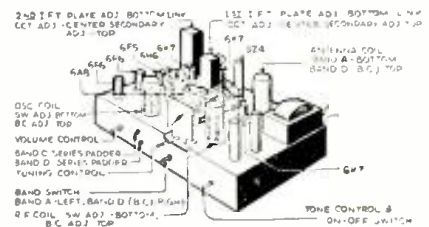

AN INSIDE STORY ABOUT METAL TUBES

(Continued from page 202)

At the same time, the metal envelope is much superior and more convenient in its function as a metal shield and in reducing inter-electrode capacity than is the skin-tight shield required in a good glass-tube arrangement. Present circuit practice demands that the grid-to-plate capacity of a typical screen-grid tube be approximately .01-mmf., or less. The metal tube reaches this tolerance with little difficulty.

X-RAY EXAMINATION

X-ray eyes would be required to see "through" the opaque metal tube. Therefore, what is more logical than that the X-ray should be used in checking the internal arrangement of the elements in defective tubes? This procedure eliminates the need for an expensive wrecking process in order to check the malformation of the elements within the normal number of tube rejects. The internal arrangement of the elements (in screen-grid arrangement) as thus disclosed by X-ray is illustrated in the central view in Fig. A (and the cover illustration), and may be compared with the exterior and cross-section views at the left and right. X-ray views of the representative types appear in Fig. G. This photograph and the preceding X-ray view were taken by the General Electric Company especially for *Radio-Craft*; (they are interesting examples of the advanced X-ray photography technique which makes it possible to obtain such excellent "separation" of the various metal elements within the steel jacket).

"OTHER" METAL TUBES

An article discussing the present status of metal tubes would be incomplete without mention of several new technical developments in related types. The consumer should acquaint himself with the following facts in order that due justice may be given to all concerned.

A Canadian manufacturer, Rogers Radio Tubes, Ltd., has just introduced a type of tube which at first glance might be confused with the steeljacket variety. However, as shown in Fig. C, the envelope is of glass, and only the

(Continued on page 233)

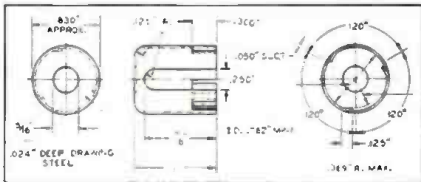
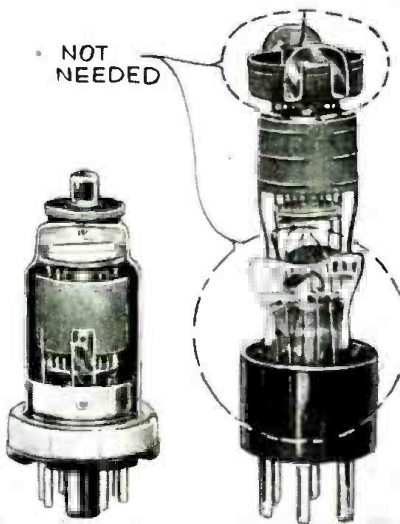

Fig. 2. This metal cap completes the shielding.

Fig. F. Illustrating metal vs. glass type.



What Does a Volume Control Replacement Job Mean to You?

A Cinch



...or a Nuisance?



This NEW 100-page **VOLUME CONTROL GUIDE**

Makes Servicing a Profitable Pleasure!

HERE'S the book of books for the active service man who wants to save time and trouble and get some fun out of his work.

Contains a complete alphabetical list of receiver models for which Electrad standard or special replacement volume controls are made. Includes name of receiver manufacturer, model number, catalog number of proper Electrad replacement control, resistance value and list price—all you need to know to make a quick, economical and thoroughly satisfactory volume control replacement.

How to obtain YOUR COPY FREE

The cost of this Guide prohibits general free distribution. But you can have a copy by return mail if you send us the flap (the part showing specification and resistance) torn from any new-type Electrad Carbon Volume Control carton, together with your business letterhead or business card. Address Dept. RC-10.



RESISTANCE SPECIALISTS

Featuring:
QUIET CARBON VOLUME CONTROLS
VITREOUS RESISTORS
TRUVOLT RESISTORS
POWER RHEOSTATS

SEND FOR THIS **FREE CATALOG**

Check full of BARGAINS in RADIO SETS, Long and Short Wave Apparatus, Servicemen's Repair and Replacement Parts, Electrical Appliances and hundreds of miscellaneous specials at **TREMENDOUS SAVINGS.** Get this big new Bargain Book. It's absolutely FREE without obligation—just send us your Name and Address on a post card **WRITE FOR YOUR COPY NOW.**

JUST OFF THE PRESS

RADIO CIRCULAR CO., INC.
 225 RC VARICK ST., NEW YORK

THOR A. C. AMPLIFIER Mode 3F.
 4 WATTS 1-57 1-2A5 1-80

No single feature has been overlooked in making this an outstanding amplifier. The circuit is one of simplicity—yet employing the latest in tube circuit design.

This 3-tube A.C. Amplifier Kit with complete parts for construction, including wiring diagram and instructions. **\$5.95**

DYNAMIC SPEAKER \$2.50 EXTRA—SET OF MATCHED TUBES \$1.52 EXTRA. Kits shipped Ready Mounted. Send for FREE Circuit Data. Special: FREE DIAGRAMS sent upon request for any of the THOR Amplifier or Tuner Kits.

MAIL ORDERS PROMPTLY FILLED

THOR RADIO CORP.
 167 GREENWICH ST. NEW YORK, N. Y.

Please Say That You Saw It in RADIO-CRAFT

TECHNICIANS' DATA SERVICE

JOSEPH CALCATERRA DIRECTOR



Send for Your Free Copy of Sylvania's New Service Book!

● Sylvania's New Volume of Service Hints is Going Like Hot Cakes . . . Send for Your Free Copy Today . . . Up-to-the-Minute Service Tips from Radio Men All Over the Country. Short cut solutions . . . new ways to solve every-day problems . . . hundreds of handy methods discovered by practical service men! That's what you'll find in Volume 2 of Service Hints . . . and it's yours without any charge whatever! In this FREE booklet Sylvania has compiled, hundreds of successful service men give you the lowdown on tough problems they have solved . . . problems you might run into any day. Their tips may save you hours of trouble-shooting on some hard-to-crack job. Don't wait. Send today for Volume 2 of SYLVANIA SERVICE HINTS. It contains inside dope on receiver troubles that will iron out your own problems, and put you in line for more and better service jobs. And remember . . . there's no charge at all. Simply fill out the coupon below today . . . and you'll get your copy of Service Hints in a few days. Hygrade Sylvania Corporation, Makers of Sylvania Radio Tubes and Hygrade Lamps, Factories at Emporium, Pa., Salem, Mass., and St. Mary's, Pa.

FREE! Send for Your Copy Today.

Sylvania

THE SET-TESTED RADIO TUBE

Hygrade Sylvania Corporation, Emporium, Pa. Please send me free, without obligation, Volume 2 of Sylvania's "Service Hints." Employment Amateur Call Serviceman Employed by dealer Independent

Member Service Organization.....

NAME.....

ADDRESS.....

CITY..... STATE.....

NAME OF JOBBER.....

ADDRESS..... Rv-10

The literature listed in this department contains a wealth of very useful information.

A special arrangement between RADIO-CRAFT magazine and the publishers of this literature, which permits bulk mailings to interested RADIO-CRAFT readers, eliminates the trouble and expense of writing to each individual organization represented in this department.

2. HAMMARLUND 1935 CATALOG. Contains 12 pages of specifications, illustrations and prices on the new line of Hammarlund variable, mid-gate, band-spread and adjustable condensers; trimming and padding condensers; R.F. and I.F. transformers, coils and coil forms; sockets, shields, chokes and miscellaneous parts for ultra-short-wave, short-wave and broadcast operation.

3. HOW TO GET A HAMMARLUND 1935 SHORT-WAVE MANUAL. A circular containing a list of contents and description of the new 16-page Hammarlund Short-Wave Manual, which contains construction details, wiring diagrams, and list of parts of 12 of the most popular short-wave receivers of the year.

4. THE "COMET PRO" SHORT-WAVE SUPERHETERODYNES. Describes the outstanding features of the standard and crystal-type Hammarlund "Comet Pro" short-wave superheterodynes designed to meet the exacting demands of professional operators and advanced amateurs for a 15 to 250 meter code and phone receiver, but which can be adapted by anyone for laboratory, newspaper, police, airport and steamship use.

5. ELECTRAD 1935 VOLUME CONTROL AND RESISTOR CATALOG. Contains 12 pages of data on Electrad standard and replacement volume controls. Truvolt adjustable resistors, vitreous wire-wound fixed and adjustable resistors and voltage dividers, precision wire-wound non inductive resistors, center-tapped filament resistors, high-quality attenuators, power (50- and 150-watt) rheostats and other Electrad resistor specialties.

25. LYNCH NOISE-REDUCING ANTENNA SYSTEMS. Complete descriptions and instructions issued by Arthur H. Lynch, Inc., for making all kinds of antennas for broadcast and short-wave reception, with a special supplement covering Ham Antenna Design for transmitting as well as receiving all the amateur bands, including the ultra-high frequencies.

26. LYNCH AUTO RADIO ANTENNAS, FILTERS AND NOISE SUPPRESSORS. This folder describes a complete line of Lynch antennas, filters and ignition noise suppressors designed for auto radio installations. The antenna system is of the under-the-car type for easy installation. It includes data on Hi-Gain matched-impedance transmission lines which make the under-car antenna highly desirable for use with the new "Turret-top" cars.

28. LYNCH SUPER-FILTASTATS FOR AUTO RADIO INSTALLATIONS. Describes and illustrates, with instructions for using, the new Lynch Super-Filtastats which do away with the need for suppressors in auto-radio installations, giving better performance in operation for both the car and radio set.

34. SERVICE MAN'S 1935 ELECTRAD REPLACEMENT VOLUME CONTROL GUIDE. A 52-page vest-pocket size booklet containing a revised, enlarged and complete list, in alphabetical order, of all old and new receivers showing model number, value of control in ohms and a recommended Electrad control for replacement purposes. Contains specifications and volume-control circuits for over 2,000 receiver models.

57. RIBBON MICROPHONES AND HOW TO USE THEM. Describes the principles and operating characteristics of the Amperite velocity microphones. Also gives a diagram of an excellent humless A.C. and battery-operated preamplifier.

62. SPRAGUE VOLTAGE TABLES. A folder and sample pages giving details of a new 300-page book, containing 1,500 "Voltage Tables" covering receivers manufactured from 1927 to date, published by Frank L. Spragberry to simplify radio servicing.

64. SUPREME No. 385 AUTOMATIC TESTER. A technical bulletin giving details, circuits and features covering this new Supreme development designed to simplify radio servicing. In addition to the popular features of Supreme

Radio-Craft Technicians' Data Service
99 Hudson Street,
New York City, N.Y.

Please send to me, without charge or obligation, the catalog, booklets, etc. the numbers of which I have circled below.

2	3	4	5	25	26	28
34	57	62	64	67	72	74
75	76	77				

My radio connection is checked below:

- Service Man operating own business.
- Service Man for manufacturer.
- Service Man for jobber.
- Service Man for dealer.
- Service Man for servicing company.
- Dealer.
- Jobber.
- Experimenter.
- Professional Set Builder.
- Amateur Set Builder.
- Licensed Amateur.
- Station Operator.
- Radio Engineer.
- Laboratory Technician.
- Public Address Worker.
- Manufacturer's Executive.
- Student.
-

I am a:

- Subscriber Newsstand reader

I buy approximately.....of radio material a month. (Please answer without exaggeration or not at all.)

Name

Address

City..... State.....

(Please print name and address)

Avoid delay. The catalogs and booklets listed are now in stock and will be sent promptly as long as the supply lasts.

analyzers and tube testers it contains many direct-reading features which eliminate guesswork or necessity of referring to charts or tables.

67. PRACTICAL MECHANICS OF RADIO SERVICE. Information, including cost, features and outline of lessons of the Frank L. Sprayberry course in Radio Servicing, and list of Sprayberry Data Sheets for modernizing old radio equipment.

72. HALLICRAFTERS' SKYRIDER SHORT-WAVE RECEIVERS. Description of the Skyriders tuned R.F. and Super Skyriders superheterodyne short-wave receivers designed and built by Hallicrafters, Inc. Features: range of 13 to 200 meters (with broadcast or 10-meter band optional), automatic wave-change switch, continuous band-spread, built-in monitor, speaker and power supply (or batteries), high-fidelity audio, and other refinements.

74. SPRAGUE 1935 ELECTROLYTIC AND PAPER CONDENSER CATALOG. Gives specifications, with list and net prices on a complete line of wet and dry electrolytic, and paper condensers made by the Sprague Products Co. for radio Service Men, set builders, experimenters and engineers. Information on the Sprague Capacity Indicator, for making capacity tests on condensers and in servicing receivers, is included.

75. SPRAGUE TEL-U-HOW CONDENSER GUIDE. A valuable chart, compiled by the Sprague Products Co. which tells the proper types, capacity values and voltages of condensers required in

(Continued on page 237)

Please Say That You Saw It in RADIO-CRAFT

AN INSIDE STORY ABOUT METAL TUBES

(Continued from page 231)

"octal" (8 prong) base is of the metal type. The glass bulb is given a metal coating; from this process is derived the term—"metal-spray" tube. The metal-spray tube is completely shielded from top to the bottom of the base; it is furnished in dual-purpose types. The new interior construction of the tube includes the cementing of the grid rod to the ceramic top-support, together with expanding and sealing of the cathode tubing to this ceramic support. This eliminates the possibility of noise due to vibration, as well as the possibility of hum from the cathode tubing or poor emission from the cathode coating.

A second variation has been brought out by Triad Manufacturing Company, Inc., and is illustrated in Fig. D. These metal-glass tubes are known as the MG series and are not all-metal, there being a glass inner sleeve which is used for maintaining the vacuum.

The MG series at present includes the following types: 5Z1MG, 6A5MG, 6C5MG, 6D5MG, 6F6MG, 6H6MG, 6F7MG, 6K7MG; the characteristics of these tubes are said to parallel those of all-metal construction. There is available in addition the following types, for use in A.C.-D.C. sets: 25Z5MG and 43MG, with characteristics similar to those of the types 25Z5 and 43 tubes; there is also available a type 50A2MG tube, which is a ballast tube in a metal shield with a tap to supply two No. 40 pilot lights in series, and type 50B2MG, similar to the 50A2MG except that it is tapped to supply only a single No. 40 pilot lamp. Both ballast tubes have an over-all drop of 50 V.

The tubes in the MG series incorporate standard octal bases.

Finally, there is the type of tube which, while it incorporates an octal or 8-prong base, utilizes a glass envelope and depends for its shielding upon an external shield. This glass-"metal" tube described in the August, 1935 issue of *Radio-Craft* as item No. 754, is illustrated here in Fig. E. The characteristics are said to approximate those in the regular metal series. The latest step towards securing identical characteristics has been to use a skin-tight shield of improved design. This shield is illustrated in the latest in Radio Department of the October issue as item No. 820. The glass-"metal" series, identified by the suffix letter G, is a product of Acturus Radio Tube Co.

CONCLUSION

It is interesting to speculate on how many manufacturers of test equipment may have provided switches to take care of the unavoidable discrepancies that so far have arisen in the "standardization" process in connection with metal tubes.

We refer specifically to the types 6F5 and 5Z4 tubes.

Metal 6F5 is a high- μ triode, with its plate connected to No. 4 terminal instead of the No. 3 terminal utilized for plate connection in the other amplifier tubes in the metal series. This connection to No. 4 terminal eliminated undesirable circuit regeneration.

Metal 5Z4 is a full-wave rectifier about equivalent to the glass 80; therefore, its filament potential is 5 V., against 6.3 for the remaining tubes in the metal series. To prevent damage to the 5 V. filament of the rectifier if plugged into one of the 6.3 V. sockets, or to the plates of the 6.3 V. tubes due to high voltage if plugged into the rectifier socket, the rectifier filament terminal wires are connected instead to

(Continued on page 241)

Fig. G. G.E. X-ray photos of metal tubes.

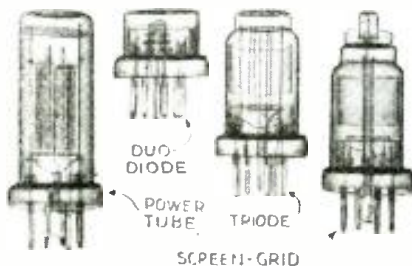

MUTER DE LUXE TUNING SELECTOR

Reduces Static
Increases Volume
Increases Selectivity
Reduces Interference

"BIG AJAX"

IF STATIC, interference, low volume or poor selectivity keep you from getting the most out of your all-wave set—get "BIG AJAX." If you want QUIET European reception—get "BIG AJAX."

IMPROVES FOREIGN RECEPTION

Muter has met your doublet antenna problem—and solved it—with this new impedance matching tuning selector. Hook it up between the antenna and your set and your troubles are over. Easy switch adjustment takes care of almost any reception troubles.



Get one from your jobber—or mail the coupon NOW and this All-Wave Tuning Selector will be sent to you at once, postage paid. And, of course, it removes your reception troubles or your money will be immediately refunded.

MAIL THIS COUPON!

"LITTLE AJAX"

An efficient smaller model with three-way switch, \$1.00 postage paid.



The MUTER COMPANY

1255-F S. Michigan Ave.
CHICAGO, ILL.
U.S.A.

THE MUTER COMPANY

1255-F South Michigan Avenue, Chicago, Illinois

Please RUSH me one of your "BIG AJAX." I am enclosing \$2.50. I will pay the mailman \$2.56. It must satisfy me in every way.

Please RUSH me a "LITTLE AJAX." I am enclosing \$1.00. I will pay the mailman \$1.06.

NAME

ADDRESS

CITY

STATE

for BALLYHOO ANNOUNCING OUTDOOR SOUND

The latest High-Fidelity Racon Reproduser THE TURRET PROJECTOR

Weatherproof for all service where excellent quality and progressive power is required. Features the new Racon BROAD-BAND Speaker. Made with either heavy-gauge Aluminum Bell or the exclusive patented RACON UNBREAKABLE BELL STEEL TUBE. Bronze mounting bracket with type socket fitting for mounting or hanging.

Write for Sheet B6-29
Racon Electric Co. Inc., 52 East 19th St., New York, N.Y.

New! 2-in-1 ELECTROLYTICS

Two separate and distinct sections in a single aluminum can . . . four leads for individual positives and negatives . . . just the thing for filter circuits. Saves space, bother, money. Typical of versatility of Aerovox metal-can electrolytics.

DATA Latest Aerovox catalog covers entire condenser and resistor line. Copy of Research Worker included.

AEROVOX

CORPORATION
77 Washington St. Brookline, N. Y.

Please Say That You Saw It in RADIO-CRAFT

Million— TEST EQUIPMENT

Combination Tube Tester

1. Emission
2. Metal Tubes
3. Shorts
4. Leakage
5. Resistance
6. Electrolytics
7. Bypass Condensers
8. Neon alignment

DEALER'S COST
\$845
NET



Standard Vibrator Tester



1. All Vibrators
2. Positive Reading
3. Fused
4. Insulated
5. Battery Switch
6. Approved
7. Compact
8. Rect. Tubes
9. Buffers

DEALER'S COST
\$995
NET

De Luxe Vibrator Tester

Added Features

1. Spare Sockets
2. Buffer Variable
3. Polarity Switch
4. Reads Primary Current
5. 0-10 Ammeter

DEALER'S COST
\$1695
NET



Send 20% deposit with order—balance C.O.D.
All orders are F.O.B. Chicago.

MILLION
RADIO AND TELEVISION LABORATORIES
361-99 W. Superior St. Chicago, Ill.

FREE!

A complete descriptive catalog—full of the latest dope on condensers now waiting for you—

See for yourself what amazing strides Cornell-Dubilier condensers have made in the past year.

Electrolytic, paper, oil, and mica condensers illustrated in catalog 128.



CORNELL-DUBILIER
CORPORATION
4347 BRONX BOULEVARD
NEW YORK

THE NEWEST IN TREASURE LOCATORS

(Continued from page 214)

The circuits consist of a transmitter or oscillator, V1, of the Hartley type, and an oscillating detector, V2, with a stage of A.F. amplification, V3. One feature of the circuit is that it is not necessary to shield any of the parts.

The sensitivity of the unit can be adjusted to suit individual conditions, for it depends almost entirely on the voltage of the "B" battery and the size of the exploring or transmitter coil, L1. The larger this coil is made, the greater is the sensitivity of the device.

The circuit shows the arrangement used. The oscillator is a straight Hartley unit tuned by a .0065-mf. fixed condenser to the required frequency in conjunction with the exploring coil, L1, described. This .0065-mf. condenser consists of two fixed mica condensers of .006- and .0005-mf. (500 mmf.) connected in parallel.

The receiver coil, L2, is tuned by three condensers: (1) a 250 mmf. (.0025-mf.) variable air condenser for fine adjustments; (2) a .001-mf. mica compression-type trimmer condenser for rough adjustment; and (3) a .014-mf. fixed

condenser which is made up of a .001-mf. mica unit and a .01-mf. paper condenser. These five condensers permit the receiver coil to be tuned to the same frequency as the oscillator.

The coils are wound according to the sketch, Fig. 2. The oscillator coil, L1, is center-tapped and consists of 30 turns of No. 20 cotton-covered wire on a wooden frame 20 ins. square. (To prevent hand-capacity effects it may be desirable to place an open-circuit turn of screening over the outside, as described in the article, "How to Make a Simplified 'Treasure' Locator," in the preceding August 1935 issue.)

The receiver coil, L2, is smaller than the oscillator inductance, and is mounted inside the case with the tubes and batteries. It is center-tapped, and consists of 70 turns of No. 24 cotton-covered wire on a wooden frame 3 1/2 x 4 ins. and wide enough to accommodate the 70 turns.

A socket is mounted on the inside of the frame of L1; a plug and cable then connect this coil to the remainder of the equipment.

The phone jack used with this unit is one of the filament-control type which connects the filaments of the tubes to the positive side of the filament battery when the phone plug is in place. In this way, the phone plug acts as a filament switch.

The layout of parts and the values of all the parts can be seen from the sketches and photos.

The volume of the beat-note signal heard in the phones is brought to maximum by carefully adjusting the position of L2; the wing-nut is then tightened. The position of L1 is carefully adjusted for zero-beat signal and then its wing-nut, too, tightened. The "softer" signal is the more stable—for equal sensitivity; change tubes until a combination is found which does not change the beat note.

In operation, the receiver tuning condensers are then adjusted until the signal from the oscillator is picked up. Finally, the vernier condenser (the 250 mmf. unit) is turned slowly until the "zero beat" (no sound) of the oscillator is attained. The device is then ready for use. It is simply moved about the spot to be checked, keeping the search coil as near the ground as possible. The presence of metal is detected by the changing of signal; practice will result in improved results.

The sensitivity of the device depends entirely upon the quality of material used, the size of the search coil (if a larger-diameter one than described is used the number of turns must be reduced), the "B" battery voltage used for the oscillator, and the care with which the device is adjusted.

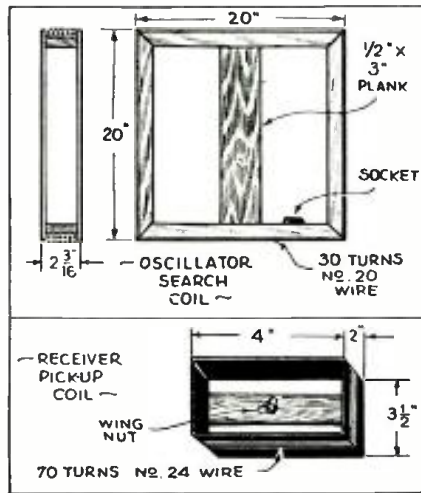

Fig. 2.—Complete details for construction of coils.

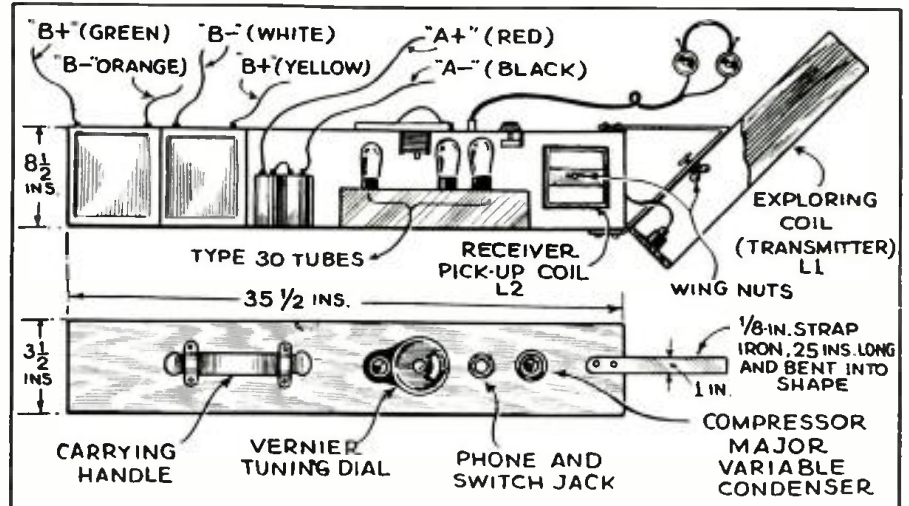
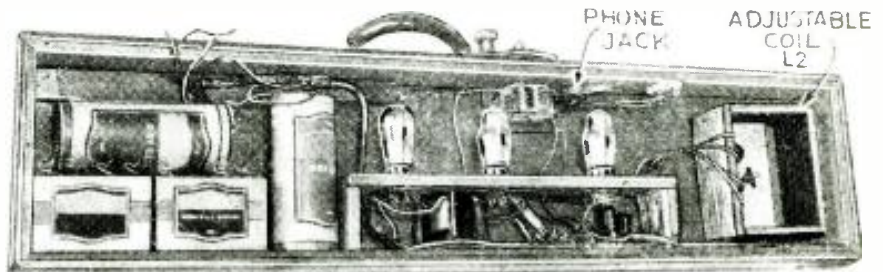

Fig. 3, above, and Fig. 8, below. Treasure locator details.



Please See That You Saw It in RADIO-CRAFT

MAKING AN ALL-WAVE SERVICE OSCILLATOR

(Continued from page 215)

put is the measuring of small condensers that cannot be measured with the usual capacity meter. Condensers from 1 to 250 mmf. may easily be measured with the use of the chart shown in Fig. 2 as follows.

Insert a speaker plug into jack J, Fig. 2 and attach a piece of rigid wire to each terminal of the plug. The wire should not be longer than 2 ins., otherwise a slight discrepancy will be found in the chart calibrations. Set the range switch to the 400-800 kc. band and tune the oscillator to read 5,000 kc. for curve 1 or 5,000 kc. for curve 2. Attach output of generator to receiver and tune in the signal on the broadcast receiver. Connect the unknown condenser across the two protruding wires from the speaker plug and rotate the oscillator tuning dial until the signal is heard again in the receiver. Note the dial reading and from the chart read the capacity at the intersection of the frequency:

Variable attenuation is provided by the output control and in addition to this there is a high and low attenuation switch that gives additional attenuation which is so necessary on the high frequencies. For those who may have occasion to run selectivity curves on receivers, the output attenuation may be expressed in decibels down. This calibration is made on the basis of constant output and without knowing the actual amplitude of the output. Assuming equal impedance, the formula for obtaining the decibel attenuation is as follows:

$$\text{db-20 log}_{10} \frac{R1}{(R2)}$$

where R1 is 1,000 ohms and R2 is the resistance between arm and ground. Therefore, the attenuation in decibels is merely on the basis of the resistor values.

TABLE 1

db. Down	Output Dial Reading
0	100
2	80
4	63
6	50
8	40
10	32
12	25
14	20
16	16
18	13
20	10

As the chassis and panel may be obtained dilled, the actual construction of this oscillator will not take longer than an hour to complete and is very simple to do. The only precautions to observe is to keep all wiring as short as possible and shield the wire going to the attenuator. A mechanical detail that may require a little explanation is the dismantling of the dial to attach the new calibrated dial. The dial

is dismantled as follows. Remove the nickel hub in the center of the dial with a slight pull outwards. Remove the tuning dial knob and take out the pin in the shaft. This will release the spring and free the dial plate. Cut out the new paper dial around the inner and outer circle, place centrally on the dial plate, and fasten with service cement. Remove the celluloid window from the bakelite dial case and cut out a piece of celluloid similar, only extend the end so that the aperture is entirely covered. With a sharp knife or razor blade drawn lightly over the celluloid, a fine index line can be made and when inked in will show very vividly when placed against the white background of the dial. Locate the index line in the center of the aperture and fasten the celluloid to the bakelite case with cement.

LIST OF PARTS

- One RCA coil kit, L1 to L19;
 - One Jack, J;
 - One RCA dial scale;
 - Two S.P.S.T. switches, Sw.1 and Sw.3;
 - Five name plates;
 - *One dial;
 - *One transformer, T1;
 - *One transformer, T2;
 - One Aerovox mica condenser, .001-mf.;
 - One Aerovox mica condenser, 100 mmf.;
 - One Aerovox mica condenser, .003-mf.;
 - One Hammarlund choke, 10 mhy, R.F.C.;
 - *One cabinet;
 - One Elecrad potentiometer, type 276W;
 - One Blan S.P.D.T. switch, Sw.2;
 - Two Blan 4-prong wafer sockets;
 - One Blan microphone terminal strip;
 - One Universal microphone, model X;
 - One Universal X desk mount;
 - One Blan matched tuning condenser;
 - Two Blan output posts;
 - One Blan drilled chassis.
- *Manufacturer's name upon request.

TECHNICIANS' DATA

(Continued from page 232)

the various circuits of radio receivers and amplifiers, and how to locate radio troubles due to defective condensers. Includes data on condenser calculations.

76. FACTS YOU SHOULD KNOW ABOUT CONDENSERS. A folder, prepared by the Sprague Products Co., which explains the importance of various characteristics of condensers, such as power-factor, leakage, capacity and voltage in determining the efficiency or suitability of a given condenser to provide maximum filtering and safety in operation.

77. SUPREME 391 P.A. ANALYZER. This booklet describes the features and use of the new Supreme 391 P.A. Analyzer, designed to equip the radio Service Men to cash in on the constantly growing opportunities for service in the sound equipment and public address systems used in movie theatres, schools, churches, auditoriums, etc.

Fig. 2. The curve below shows the calibration for use when testing unknown condensers for capacity.

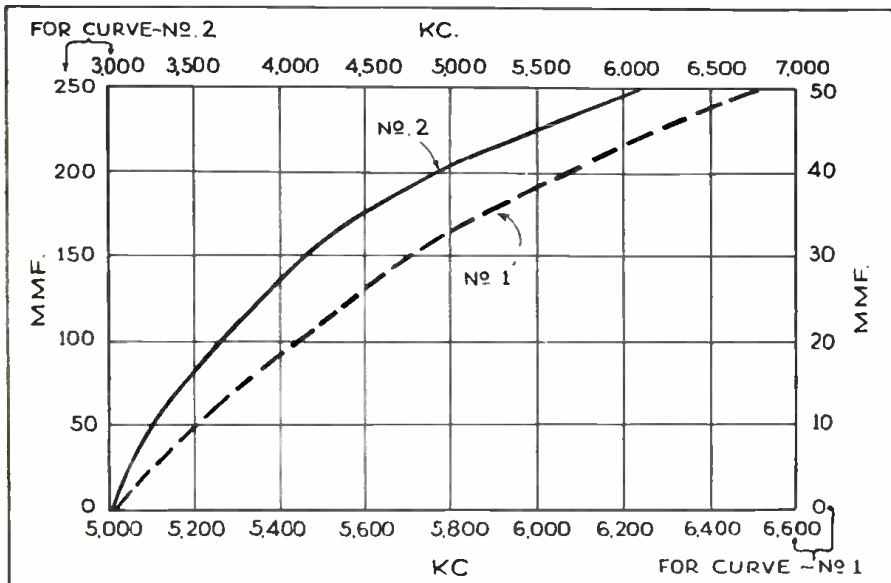

Please Say That You Saw It in RADIO-CRAFT

WORTH Cheering ABOUT!



the New

1936 ALLIED RADIO CATALOG READY NOW

NEW: Metal tube receivers—you'll find a complete line in the new FREE 114 page ALLIED Catalog. There are models for every requirement—4, 5, 6, 7, 8 and 9 Tube receivers. Dual Wave, All-Wave, Broadcast, Short Wave, AC, AC-DC, battery, 32-Volt, and Auto Radios.



NEW: An amazing array of Public Address equipment. Latest portable sound systems; new 6-Volt single unit mobile outfits; 4, 10, 18, 26, 30 and 50 watt amplifiers; new ribbon, carbon, and crystal microphones; new speakers; recording apparatus, etc.



NEW: A great up-to-the-minute Amateur section. Hundreds of new items: new transmitting tubes, transformers, crystals, Short Wave receivers, etc. Latest Set-building Kits, Short Wave, All-Wave, Transceivers. Everything for Short Wave Receiving and Transmitting.



NEW: Latest test equipment to handle metal tube circuits. Complete listing of all new metal tubes; thousands of exact duplicate replacement parts, tools, accessories—all at lowest wholesale prices. Be sure to write for your FREE 1936 ALLIED Catalog.



CLIP THE COUPON

ALLIED RADIO

ALLIED RADIO CORPORATION
833 W. Jackson Blvd.
Chicago, Ill., Dept. D1.

Send me your FREE 1936 Radio Catalog.

Name

Address

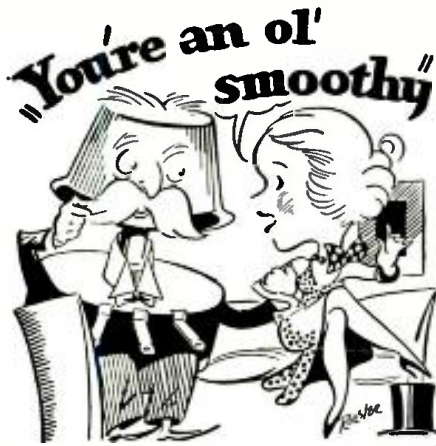

Yes sir . . . he's a smooth article . . . and that's why **SERVICEMEN** and Experimenters everywhere pin their faith on **CENTRALAB** Controls.

Smooth . . . of course . . . for the Centralab Radiohm employs that famous patented non-rubbing contact that never seems to wear out and gives a replacement service that invariably works "better than ever before."

. . . and you don't need a big stock to be able to service practically any job.



Centralab
Division of Globe-Union Mfg. Co.
Milwaukee, Wis.

Every Radio Service Man should be a member of the Institute of Radio Service Men

Centralab
RADIOHM

"HEY FELLAS"
HERE'S SOMETHIN'
REAL HOT" says
"EMANUEL ESICO"



An electric iron that stays hot no matter how much soldering you are doing—an iron that won't burn out if you leave it on over-night, as you oftentimes do. A handy little iron in fact. A low priced iron with high priced characteristics.

Your cost as low as 66¢* at all Esico distributors.

*Model Nick Nack—55 watts.

Electric Soldering Iron Co., Inc.
342 West 14th Street New York, N. Y.



RAYTHEON
TRADE MARK

4-PILLAR RADIO TUBES
Write for FREE 1935 Tube Chart
RAYTHEON PRODUCTION CORP., Dept. E-10,
30 East 42nd St., New York, N.Y.

ULTRA-FIDELITY REPRODUCTION

(Continued from page 220)

character in the reproduction; speaker No. 2, individuality; and, No. 3, depth.

It is intended that the entire instrument be constructed in units. As shown in Fig. 1, three chassis are needed, the receiver and first audio stages in one; the intermediate and high-frequency power unit in the second; and the low-note intensifier in the third. These together with the automatic phonograph turntable are housed in the console.

To assist in combatting hum and to minimize the danger of one chassis touching another (this would result in disaster due to their differences in potential), the three units should be separated as much as the dimensions of the cabinet will allow.

No values have been specified for chokes Ch6, 10 and 11. However, knowing their use and what they are supposed to do, the constructor can easily improvise them from a variety of sources.

Choke Ch6 is of fair size. Upon it we depend for the blocking of all notes above 70 cycles. It is assisted in this function by C33, which is seldom above 0.2-mf. in capacity.

Choke Ch10 is relied upon to block only those frequencies above 4,000 cycles. It is the smallest of the three and is usually aircore.

Choke Ch11 preserves the higher notes down to about 1,000 cycles at which point condenser C31 becomes effective in attenuating the frequencies. Thus only the noisiest middle notes are softened in some of the poorest broadcasts where such action is of merit. (It is not used in the majority of instances.)

(The writer will be glad to cooperate with radio men who wish to secure detailed specifications for sound systems to meet individual needs. Don't forget postage, O.M.)

LIST OF PARTS

One Hammarlund 3-section 360 mmf. variable condenser with tracker, C;
Nine Cornell-Dubilier 0.1-mf. condensers, C1, C2, C4, C9, C28, C29, C30, C31, C35;

- Three Cornell-Dubilier 250 mmf. condensers, C3, C7, C8;
- Three Cornell-Dubilier 0.5-mf. condensers, C5, C32, C34;
- Two Cornell-Dubilier 1 mf. condensers, C6, C16;
- Ten Solar 8 mf. electrolytic condensers, C10, C17, C18, C19, C21, C22, C23, C24, C25, C26;
- Two Solar 2 mf. condensers, C11, C27;
- Two Cornell-Dubilier .001-mf. condensers, C12, C13;
- One Cornell-Dubilier .0025-mf. condenser, C14;
- One Cornell-Dubilier .005-mf. condenser, C15;
- One Solar double .01-mf. condenser, C20, (see text) C33;
- Two Aerovox 400 ohm resistors, R1, R2;
- Two Electrad 50,000 ohm potentiometers, R3, R7;
- One Aerovox 20,000 ohm resistor, R4;
- One Electrad 5,000 ohm potentiometer, R5;
- One Aerovox 200 ohm resistor, R6;
- One Aerovox 1 meg. resistor, R8;
- One Electrad 10,000 ohm voltage divider with 3 sliding taps, 75 W., R9;
- Two Aerovox 0.1-meg. resistors, R11, R13;
- One Electrad 0.5-meg. potentiometer, R12;
- One Aerovox 750 ohm resistor, R14;
- One Electrad 10,000 ohm voltage divider, 50 W., R15;
- One Electrad 0.1-meg. potentiometer, R16;
- One Electrad .25-meg. potentiometer, R17;
- One Aerovox 15,000 ohm, 25 W. resistor, R18;
- One Na-Ald set of tube sockets;
- One Gen-Ral matched coil kit (for use with C). L1, L2, L3, L4, L5, L6;
- Four Gen-Ral I.F. choke coils, L7, L8, L9, L10;
- One Alloy Trans. Corp. filter choke, 30 hy., 125 ma., Ch1;
- One Alloy Trans. Corp. filter choke, 30 hy., 125 ma., Ch2;
- One Alloy Trans. Corp. filter choke, 30 hy., 200 ma., Ch3;
- One Alloy Trans. Corp. filter choke, 30 hy., 125 ma., Ch4;
- One Alloy Trans. Corp. filter choke, 30 hy., 125 ma., Ch5;
- One audio choke, see text, Ch6;
- One audio choke, 10,000 ohms, Ch7;
- One Alloy Trans. Corp. audio choke, 10,000 ohms, plus additional resistor, R, if needed, Ch8;

(Continued on page 241)

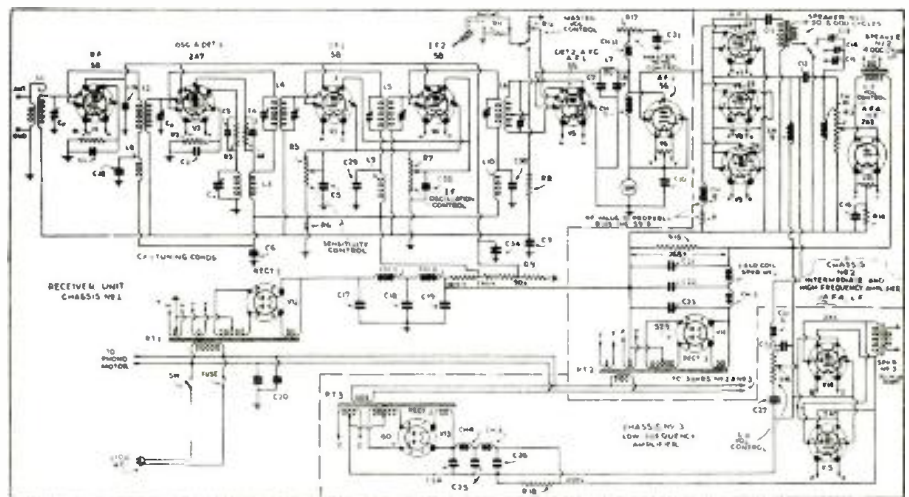
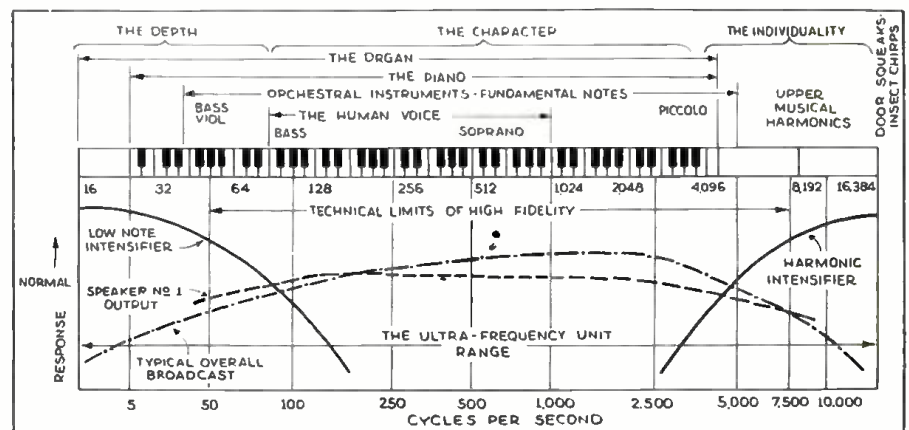

Fig. 1, above. Diagram of Ultra-Fidelity Recreator. Fig. 2, below, Frequency-characteristics comparison.



Please Say That You Saw It in RADIO-CRAFT

TESTING METAL TUBES ON A "BEGINNERS' BREADBOARD"

(Continued from page 203)

almost as quickly as it takes to say it—without the necessity of soldering a single connection! The essential units required for the hook-up board are as follows:

One, 2-gang, 350 mmf. variable condenser, with airplane-type tuning dial; one, 350 mmf. variable condenser; one, 50,000 ohm potentiometer, with attached switch; two, 4-prong (or 4-5-6 "composite") breadboard-type sockets (for plug-in coils); three, new 8-prong keyed sockets (for use with the metal tubes); one, good-quality 3½-to-1 A.F. transformer; four dozen, small fahnestock clips; one dozen, double-type fahnestock clips; and a plain, kitchen breadboard, hought from the "five and dime" store.

The terminal lugs and posts of all components have soldering fahnestock clips soldered to them for easy connection. Note the bare bus wire running diagonally across the board. This is the common ground wire, elevated for making quick connections. Be sure to follow the layout shown in Fig. A, for shortest leads.

For wiring circuits in the shortest possible time it is important to have the various components clearly labeled in easily-read characters. The tube sockets are labeled according to the RCA number system—underside view. This should be of great assistance to the beginner, inasmuch as most of the circuits appearing in radio magazines use this system.

The R.F. coils comprising the tuned circuits of any of the receivers to be built on this board should be of the plug-in type. This makes the whole scheme more flexible, for circuits are not limited to any particular type but may be either short-wave or all-wave. The use of composite sockets for these coils will permit the use of 3-winding coils for circuits which require them.

Figure 1 represents a typical circuit which can be constructed in a very short time, with the help of this clip set. It is a 3-tube, all-metal tube set, with 1 stage of R.F., followed by a regenerative detector and, finally, a power output. A swell circuit for ruralites.

Figure 2 shows this same circuit in a physical form for the convenience of the beginners.

LIST OF PARTS

- One Acratex 2-gang variable condenser, 350 mmf.;
- One Acratex variable condenser, 350 mmf.;
- Two Acratex sets of 4-prong broadcast plug-in coils;
- One Acratex 50,000 ohm volume control, with switch attached;
- One Acratex micro-vernier airplane dial;
- One Acratex, A.F. Transformer, 3½ to 1 ratio;
- Three Alden 8-prong, metal-tube-type sockets;
- Two Alden 1-prong (or composite 4-5-6-prong) coil sockets;
- Four dozen small-size fahnestock clips;
- One dozen double-type fahnestock clips;
- One "five-and-dime" breadboard, size 14" x 10" by ½ in. thick;
- Three bakelite knobs;
- Miscellaneous hardware, etc.

A 3-BAND METAL-TUBE SUPERHETERODYNE

(Continued from page 210)

consumption is rated at 45 watts. The circuit for this thoroughly modern metal-tube receiver shows the trend in design—in sets using the metal-type tubes.

THE NEW BRIDGE-TYPE VIBRATOR-"B" TESTER

(Continued from page 212)

Precautions have been taken to prevent the tester from becoming obsolete by the insertion of several blank sockets which may be used at any time in the future for vibrators having different base connections. A complete chart of replacement vibrators is supplied with the tester, together with instructions for operating the unit. Supplements to this chart are sent to the Service Man whenever they are published.

NEW 6L7 PENTAGRID "MIXER-AMPLIFIER" METAL TUBE

(Continued from page 204)

In addition, the plate impedance of the tube remains high—which is not true of a pentode tube with suppressor injection.

All these desirable characteristics plus the low inter-electrode capacity resulting from "metal tube design" makes this tube almost ideal for frequency conversion in all-wave receivers.

THE 6L7 AS AN AMPLIFIER

The 6L7 has another very important application which is likely to make it a very popular tube in the new sets. Since it is a variable-mu pentode, with desirable characteristics, it can be adapted very nicely as an R.F. or I.F. amplifier. And, what is perhaps even more important, the two control-grids permit the "injection" of an A.V.C. voltage from a diode detector into control-grid G3—resulting in an improved method of automatic volume control. Since the A.V.C. control is independent of the input circuit, the usual difficulties of reduced selectivity and varying sensitivity are eliminated. The method of applying the tube to this purpose is shown in Fig. 2.

The dual control of this tube should also find many applications in "small" sets and we will no doubt find many trick circuits, such as reflexes, etc., designed around the 6L7.

Two interesting characteristic curves (Raytheon) are shown in Fig. 3. The first, Fig. 3A, shows the relative conversion gain, for different injection-grid bias values (oscillator grid voltage) between 0 and -60 V.

The second curve also shows the conversion gain, but, in this case the oscillator grid voltage is maintained constant by using an arrangement such as shown in Fig. 1B and the screen-grid (G2 and G4) voltage is varied between 50 and 150 V.

CHARACTERISTICS

Mixer-Amplifier

- Heater Rating**
 - Voltage, 6.3 V.
 - Current, 0.3-A.
- Direct Inter-electrode Capacities**
 - Grid No. 4 to plate, .001-mmf.
 - R. F. Input, 8.5 mmf.
 - Oscillator Input, 11.5 mmf.
 - Mixer Output, 13. mmf.
- Converter Operation**
 - Plate Voltage, 250 V. max.
 - Screen-grid Voltage, 150 V. max.
- Typical Converter Operation**
 - Plate, 250 V.
 - Screen-grid (G2 and G4), 150 V.
 - Control-grid (G1), -6 V.
 - Injection-grid (G3), -20 V.
 - Peak Oscillator V. applied to G3, 25 V.
 - Plate Current, 3.5 ma.
 - Screen-grid current, 8.0 ma.
 - Plate Resistance, greater than 2 meg.
 - Conversion Conductance, 325 mmhos.
 - Conversion Conductance at -45 V. Bias on Grid, G1, 2 mmhos.
- Typical Amplifier Operation**
 - Plate, 250 V.
 - Screen-grid, 100 V.
 - Control-grid (G1), -3 V.
 - Injection-grid (G3), -3 V.
 - Plate Current, 5.3 ma.
 - Screen-grid Current, 5.5 ma.
 - Plate Resistance, 0.8-meg
 - Mutual Conductance, 1,100 mmhos.
 - Mutual Conductance
 - G1 at -21 V.; G3 at -12 V. 10 mmhos.

Fig. 4, below. An exaggerated, but relatively accurate picture of the operation of the pentagrid converter, showing oscillator failure on S.-W. bands.

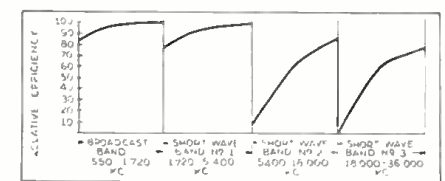

Complete... Inexpensive WESTON-built



Instruments for profitable servicing

To servicemen who feel that Weston quality is beyond their means, we present the above group comprising a complete set of Weston instruments for profitable servicing. It consists of Model 698 Selective Set Servicer, which employs the Weston Method of Selective Analysis and is equipped for the new metal tubes . . . the Model 692 Oscillator . . . the Model 687 Output Meter and the Model 780 Capacity Meter. As a servicing group, considering the quality and wide range of usefulness of these instruments, the price is relatively low . . . affording the average serviceman full opportunity to secure the dependability and long life for which Weston instruments are famous. Send the coupon for complete data . . . Weston Electrical Instrument Corporation, 599 Frelinghuysen Ave., Newark, New Jersey.

WESTON Radio Instruments

WESTON ELECTRICAL INSTRUMENT CORPORATION
599 Frelinghuysen Ave., Newark, New Jersey
Send me complete data on Weston Radio Instruments.
Name _____
Address _____

Please Say That You Saw It in RADIO-CRAFT

Now—a high-powered—



Radio Engineering Library

—especially selected by radio specialists of McGraw-Hill publications

—to give most complete, dependable coverage of facts needed by all whose fields are grounded on radio fundamentals

—available at a special price and terms.

These books cover circuit phenomena, tube theory, networks, measurements, and other subjects—give specialized treatment of all fields of practical design and application. They are books of recognized position in the literature; books you will refer to and be referred to often. If you are practical designer, researcher or engineer in any field based on radio, you want these books for the help they give in hundreds of problems throughout the whole field of radio engineering.

5 volumes, 2981 pages, 2000 illustrations

1. Everitt's COMMUNICATION ENGINEERING
2. Terman's RADIO ENGINEERING
3. Chaffee's THEORY OF THERMIONIC VACUUM TUBES
4. Hund's HIGH FREQUENCY MEASUREMENTS
5. Henney's RADIO ENGINEERING HANDBOOK

10 days' examination. Special price. Monthly payments, \$26.00 worth of books cost you only \$23.50 under this offer. Add these standard works to your library now; pay small monthly installments, while you use the books.

SEND THIS ON-APPROVAL COUPON
McGraw-Hill Book Co., Inc.
 330 W. 42nd St., New York, N. Y.

Send me Radio Engineering Library, 5 vols., for 10 days' examination on approval. In 10 days I will send \$2.50, then few cents postage, and \$3.00 monthly till \$23.50 is paid, or return books (prepaid). (We pay postage on orders accompanied by remittance of first installment.)

Name.....
 Address.....
 City and State.....
 Position.....
 Company..... R-1115

CHEKATUBE \$15.95 (f.o.b. Factory)

TESTS METAL TUBES and all others without adapters. Also HT rectifiers, Diode-Second plate. Automatic plate short, with Neon white filament light. Scale shows POOR, GOOD and line volts on sensitive D'Arsonval type meter. Portable type—cover not shown—size 10x11x6 inches. Weight 10 lbs. Highest grade equals \$10 testers—Money Back Guarantee—regular price \$21—order today for only \$15.95 cash or \$2 with order for C.O.D. shipment.

Established 1922 **J-M-P Manufacturing Co., Inc.**
 3032 N. 34th St. Milwaukee, Wis.

EVEREADY SERVICE CEMENT
 "The Original Speaker Cement"

This is the best cement for soldering speaker cones, or repairing old speakers or any other electrical equipment. It is made of purest materials, and is the only cement that will hold in place any material that is subjected to vibration, heat and moisture. It is the only cement that will hold in place any material that is subjected to vibration, heat and moisture. It is the only cement that will hold in place any material that is subjected to vibration, heat and moisture.

General Cement Mfg. Co., Rockford, Illinois

A METAL-TUBE ALL-WAVE TUNER

(Continued from page 206)

to the main pointer.

The only additional apparatus required for use with the tuner unit is the A.F. amplifier and power-supply system of the radio receiver being modernized. One lead from the tuner connects to the grid of the first A.F. tube of the audio amplifier and a potential of 250 V. filtered D.C. is also obtained from the amplifier and power supply used in conjunction with the tuner. The output of this tuner, if coupled to a high-quality A.F. system, can faithfully reproduce all frequencies up to 15,000 cycles.

TABLE I

Tube type	3	4	5	6	Cap.
V1	250 V.	100 V.	—	—	-3. V.
V2	250 V.	100 V.	25 V.	100 V.	-3. V.
V3	250 V.	100 V.	—	—	-3. V.
V4	250 V.	100 V.	—	—	-3. V.
V5	250 V.	—	-8. V.	—	—
V6	—	—	—	—	—

(Filament voltage—terminals 2 and 7—is 6.3 V.)

A list of parts follows, to facilitate the construction of the unit:

LIST OF PARTS

- One Wilco model "B" chassis base;
- One Wilco 3-section 365 mmf. variable condenser;
- One Wilco dial and drive assembly;
- One Wilco 6-section range switch;
- One 6 V. filament transformer;
- Six sockets;
- One Wilco coil kit;
- One Hammarlund variable high fidelity I.F. transformer, L13;
- One Wilco fixed I.F. amplifier coil, L14;
- Three Aerovox resistors, 0.1-meg., 1/4-W., R1, R7, R8;
- Two Aerovox resistors, 350 ohms, 1/4-W., R2, R15;
- Three Aerovox resistors, 7,500 ohms, 1/4-W., R3, R4, R5;
- One Aerovox resistor, 15,000 ohms, 1/4-W., R6;
- One Aerovox resistor, 1 meg., 1/4-W., R9;
- One Aerovox resistor, 0.3-meg., 1/4-W., R10;
- One Aerovox resistor, 5 megs., 1/4-W., R11;
- One Aerovox resistor, 1,000 ohms, 1/4-W., R12;
- One Aerovox resistor, 20,000 ohms, 1/4-W., R13;
- One Aerovox resistor, 30,000 ohms, 1/4-W., R14;
- One Aerovox resistor, 50,000 ohms, 1/2-W., R16;
- One Aerovox resistor, 1,500 ohms, 1/2-W., R17;
- One Aerovox resistor, 25,000 ohms, 1/2-W., R18;
- One Aerovox resistor, 300 ohms, 1/2-W., R19;
- Three Cornell-Dubilier condensers, .1-mf., 200 V., C1, C2, C10;
- Two Cornell-Dubilier condensers, .1-mf., 400 V., C3, C11;
- Three Cornell-Dubilier condensers, .1-mf., 200 V., C4, C12, C13;
- Two Cornell-Dubilier condensers, 50 mmf., C5, C9;
- One Cornell-Dubilier condenser, .002-mf., 400 V., C6;
- One Cornell-Dubilier condenser, .002-mf., 600 V., C7;
- One Cornell-Dubilier condenser, .25-mf., 400 V., C8;
- One Solar variable condenser, 200 mmf., C14;
- One Solar variable condenser, 500 mmf., C15;
- One Solar variable condenser, .01-mf., 400 V., C16;
- Two Solar variable condensers, .1-mf., 400 V., C17, C19;
- Two Solar variable condensers, .1-mf., 400 V., C17, C19;
- One Solar variable condenser, .01-mf., 200 V., C18;
- One Raytheon kit of metal tubes. (See Fig. 1).

METAL TUBES IN A HIGH-FIDELITY AMPLIFIER

(Continued from page 207)

variety, utilizing self-cleaning contacts that are noiseless in operation, furthermore they should be non-inductive, low capacity and wire-wound. In operation, the T pads used safely carry 8 W. of signal energy.

Tonal control is just as necessary in high-fidelity systems as in any other amplifier. The need for tone correction is to compensate for defects in the original program or record fidelity and for the wide range of acoustic conditions that are encountered in various locations. For tone compensation, the reader is referred to the article "High Fidelity by Equalization," *Radio-Craft*, June, 1935.

To feed an R.F. tuner to this amplifier it is suggested that this be accomplished through the use of a suitable plate-to-line transformer and the volume can then be controlled with the T pad as shown.

LIST OF PARTS

- *One transformer, T1;
- *One transformer, T2;
- *One transformer T3;
- *One transformer, T4;
- *One transformer, T5;
- *One transformer, T6;
- *One choke, CH1;
- *One choke, CH2;
- One Electrad transformer pad, type 8AT500, T;
- One Electrad resistor, 2,000 ohms, type B20, R1;
- One Electrad resistor, 1 250 ohms, type IG1250, R3;
- One Electrad resistor, 500 ohms, type IG500, R1;
- Two I.R.C. resistors, 10,000 ohms, R5, R6;
- One Aerovox condenser, 5 mf., type MM25, C1;
- One Aerovox condenser, 10 mf. type MM25, C2;
- One Aerovox condenser, double 4 mf., type GG5, C3;
- One Aerovox condenser, 8 mf., type 15-325, C4;
- One Aerovox condenser, 16 mf., type PB2-200, C5;
- *Two drilled chassis;
- Ten Blau metal tube sockets;
- One Blau off-on line switch;
- One kit of RCA, Raytheon, or Sylvania metal tubes.

(*Names of manufacturers upon request.)



Fig. C, above. Underside of amplifier.



Fig. D, above. Underside of power supply.
 Fig. 3, below. Pad connections for various lines.

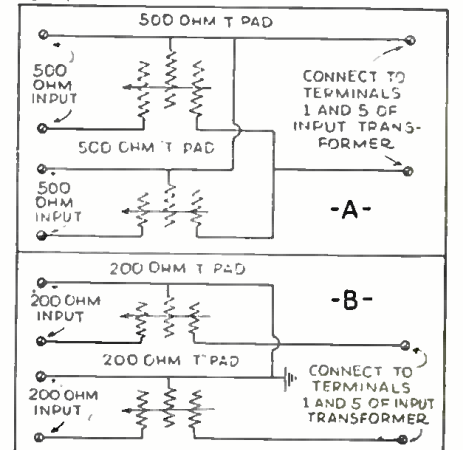

"ILLUMINATED PROBING MIRROR"

In the June-July 1935 issue of "National Radio News" appeared an article entitled, "Handy Tool," by a student, William R. Lawton. Readers of *Radio-Craft* may be interested to know that Mr. Lawton has since improved upon his original idea as shown on page 88 of the August 1935 issue.

Please Say That You Saw It in RADIO-CRAFT

AN INSIDE STORY ABOUT METAL TUBES

(Continued from page 233)

terminals Nos. 2 and 8, instead of Nos. 2 and 7 like the remaining tubes in the metal series. (We wonder how many technicians are going to cuss the circuit limitations imposed by reason of the 5Z4 filament being tied to the high-voltage side of the rectifier output?)

Service Men and experimenters who wish to revamp existing equipment in order to properly test the metal tubes should note that some analyzers have the No. 1 or ground terminal of the octal socket grounded to the metal mountings and the wiring—at the same time, the No. 8 terminal is grounded. This puts the tube shield at the rectifier cathode potential—that is, 350 V., in some instances! (An army mule can't heat the kick you'd get from that jolt!) Just remember, then, to isolate the wiring to terminals 1 and 8.

Heating of the metal tubes, as compared with the glass type, is a popular topic for discussion these days. Do the metal tubes run hotter than the glass ones of equivalent type? If they do, and the rise in temperature is due to better conduction by the steel envelope, is this an indication that the tube will perform better because the internal elements are being kept more cool? These and other questions of this nature are still to be answered; it is of exceptional interest that an article discussing the subject will appear in a forthcoming issue of *Radio-Craft*.

Some off-hand claims have been made that the metal tubes are less sensitive and more noisy than the glass predecessors. On the contrary, comparative tests between receivers utilizing similar sets each properly designed, one for the metal tubes and the other for the glass prototypes, prove that the metal tubes are MORE sensitive and LESS noisy than glass tubes!

Finally, there remains the question of whether the metal tubes will work at very high frequencies. Well, the writer is in the position of having heard a commercial metal-tube set (described elsewhere in this issue) operating on 4½ and 5 meters! It functioned with far greater tone quality, and far less static at 5 meters than did the same set at the broadcast wavelengths!

It seems, however, that in some circuits the shield of the metal tube when operated at ultra-high frequencies may exhibit hand capacity. Whether this is due to lack of conductivity of the Swedish-iron shield, to close proximity of the internal elements, or to some other reason has not as yet been definitely determined.

It is even possible that the control-grid terminal atop the tube, in some high-gain circuits may present sufficient area to cause inter-tube feedback and circuit oscillation or undue regeneration. An expedient to obviate this fault is the use of a top-cap shield, constructed as illustrated in Fig. 2.

Definitely, metal tubes are here to stay. Therefore, the radio man might just as well start right now to absorb every available bit of technical data relating to them.

ULTRA-FIDELITY REPRODUCTION

(Continued from page 238)

- One Alloy Trans. Corp. filter choke, 30 hy., 125 ma., Ch5;
 - One audio choke, see text, Ch6;
 - One audio choke, 10,000 ohms, Ch7;
 - One Alloy Trans. Corp. audio choke, 10,000 ohms, plus additional resistor, R, Ch8;
 - One Alloy Trans. Corp. choke, 225 ohms, Ch9;
 - One audio choke, see text, Ch10;
 - One audio choke, see text, Ch11;
 - One General Trans. Corp. transformer supplying 2½ V. 6 A., 2½ V. 2 A., 5 V., 700 V. center-tapped, 100 ma., PT.1;
 - One General Transformer Corp. transformer supplying 2½ V. 4 A., 2½ V. 2 A., 5 V., 800 V. center-tapped, 175 ma., PT.2;
 - One General Trans. Corp. transformer supplying 2½ V. 4 A., 5 V., 650 V., 100 ma., PT.3;
 - *One model A-12 high-fidelity, 110 V. D.C., speaker No. 1;
 - *One model Q high-range, 110 V. A.C., speaker No. 2, with reflectors;
 - *One ortho-dynamic series L, 110 V. A.C., speaker No. 3;
 - One crystal pickup;
 - One 0-200 V. voltmeter, 1,000 ohms per volt (tuning meter), VM.
- *Name of manufacturer upon request.



Glass or Metal Radio Tubes

Dependable

Suited to SERVICE MEN'S NEEDS
* HIGHEST QUALITY *
SOUND ENGINEERING

Ken-Rad Radio Tubes

THE KEN-RAD CORPORATION, Inc., OWENSBORO, KY.
Division of The Ken-Rad Tube and Lamp Corporation
Also Manufacturers of Ken-Rad Incandescent Electric Lamps

Speakers by

OXFORD



Get the facts today on the new CHROMAVOX high fidelity series. These speakers deliver an unequalled fullness and purity of tone, surpassing the requirements of the most exacting radio engineers.

Long recognized as "speaker headquarters," Oxford in its present products offers more quality than ever and the widest line from which to choose.

Send for illustrated Bulletin.

OXFORD RADIO CORP.

Dept. C, 350 W. Huron St., Chicago

ACCEPTED BY SOUND JUDGEMENT

TURN SCRAP INTO MONEY



The new and revised edition of "Auto Power" with all the ten original specifications and ten new ones is now off the press. Convert old generators into A. C. and D. C. generators and motors with voltages of 6 to 400 volts, for power, light, welding, and radio operation. Create new generators adaptable for home, automobiles, or trucks. They can be driven by fan belt, wind or water. This book with complete illustrations, tells you how easily and economically these changes can be made. Also instructions for rewinding auto armatures, 250 definitions of electrical terms, etc. Already used and endorsed by thousands. Price \$1.00 postpaid.



AUTO POWER Dept. C 414 S. Hoyne Ave. Chicago

NEW HI-LOW SILVER ETCHED, METAL VAN DIAL, No. 3X

with low range taken across meter terminals of a 50 ohm internal resistance meter. It has the regulation voltage and milliammeter scale for Models 301 and 88. Order through Your dealer
D. L. VAN LEUVEN
410 East 15th St., New York, N. Y.

NOISE-REDUCING TWINS

LYNCH HI-FI ASSEMBLED ALL-WAVE ANTENNA

All ready to bring. Saves 50% of installation time. Amazingly low price. \$6.75 List

If your dealer cannot supply you, order direct, or write for folder.

LYNCH FILTERADIO

Cuts out objectionable noise from the light bulb. Easy to install, simple to adjust. \$5.00 List

Arthur H. Lynch, Inc., 227 Fulton St., N. Y. PIONEER OF NOISE-REDUCING AERIALS

Please Say That You Saw It in RADIO-CRAFT



"JOE HAS A REAL SERVICE BUSINESS NOW!"

"No more skimping along for us! Joe's making a real success out of his radio work now. His shop is the finest, best equipped in town and he has two men working for him. We just got a new car. Next year we plan to buy our home. . . ."

"Joe" is typical of many Sprayberry trained men—fellows who take radio servicing seriously—who realize it holds a real future for those who qualify. Thanks to Sprayberry **ADVANCED TRAINING**, they have graduated from being "just another serviceman." Today they are the leading servicemen of their communities. Certainly you owe it to **YOUR FUTURE** to investigate!

Get This FREE Booklet

REMEMBER—Sprayberry offers "advanced" training only—specifically designed for servicemen who know it pays to look ahead. No "fluff," fancy bind-ings or theory here. Instead you get practical help on all phases of servicing plus sound methods for forging ahead in an efficient, professional manner. Backed with a record of success second to none—and priced at a fraction of the cost you might expect. Our **FREE** booklet describes it in detail. Send for your copy at once.

F. L. SPRAYBERRY, 2548 University Place, N. W. Washington, D. C.

Without cost or obligation, please send your booklet "PUTTING PROFITS AND EFFICIENCY INTO SERVICING."

Name

Street

Address.....RC 10/35



Listen to C-W Signals on your present all-wave receiver

The **RCA Beat Oscillator** is easily connected to any superheterodyne receiver, permitting beat reception of c-w signals. Has vernier adjustment for controlling the pitch. Powered from receiver. Uses either 2.5 or 6.3 volt tube. **Net price, \$7.50**



GET THIS CATALOG

Contains 92 pages, lists thousands of parts for replacement in any set; special replacement parts guide for RCA Victor, G. E., Westinghouse and Graybar sets. Tube

Charts. Diagrams. Ask your RCA parts distributor for a free copy.

RCA PARTS DIVISION
RCA MANUFACTURING CO., INC.
CAMDEN NEW JERSEY

THE LATEST RADIO EQUIPMENT

(Continued from page 217)

pieces being held in place by the top and bottom pieces, which snap into place. The bottom piece has a tab which springs over the ground pin on the tube, and thus grounds the shield as in the metal tubes.

7-TUBE ALL-WAVE "METAL" SET (821)

A **VERY** high ratio vernier dial is used on this set, to allow easy tuning on the short-wave bands. Metal tubes are used throughout and contribute to the quiet and efficient operation. Automatic volume control is used. Wave-band covered completely from 22.5 mc. to 540 kc. Continuously variable tone control is available.

RESISTANCE BRIDGE (822)

(The Muter Co.)

RESISTANCE measurements from .01-ohm up to 11 megohms, with an accuracy of less than 1 per cent are possible with this new instrument! It is completely self-contained, with battery and meter in the case. The operation is very simple and rapid due to the advanced design. The weight is 6 lbs. The apparatus is contained in a finely finished walnut case.

REPRODUCER AND FIELD SUPPLY (823)

(Wright-DeCoster, Inc.)

THIS cabinet is designed to be hung on the wall or it may be set on a table or shelf. It may be obtained with 8, or 10 in. speaker and universal output transformer. The finish is dark and contrasting black walnut. The separate field supply is designed to fit into the cabinet, and is for use with any 2,500 ohm field.

4 1/2 TO 2,000 METERS —AND 18 METAL TUBES (824)

(Midwest Radio Corp.)

THE frequency range of this set is very wide and covers almost every form of radio signals on the air. There are six positions on the band switch, the coverage being continuous, except for a small break at the I.F. utilized. The band switch moves the tunable and two band indicators automatically. The dial is completely calibrated, and two ratios of vernier action are available. A beat oscillator is used for ease in tuning-in weak stations, and is controlled from the panel. The audio output stage is run as class A and the output of 20 W. is fed to a 12 in. speaker.

OCTAL ADAPTERS (825)

THESE adapters are for making possible the use of 8-prong tubes or plugs in any standard 4-, 5-, 6-, or 7-pin socket. They are strongly made of bakelite and have col-

Below, No. 829. A beginner's portable all-wave set. Right, No. 830, an oil-filled, 1,000 volt condenser of very small size.



ored markings on top for identification purposes. The six adapters pictured are sold as a complete set or separately.

AN 11-METAL-TUBE CHASSIS (826)

METAL tubes are featured in this 11-tube high-fidelity chassis. The wave range is from 16 to 555 meters. Tone control is provided. The delicate elements of the tuning system are concentrated in one unit and are shock-mounted on gum rubber. Resistance-coupled audio system, with push-pull output is used. Compensated volume control which reinforces bass response at low audio levels. Selectivity can be regulated at will. Code signal trap cuts out interference.

TEST ADAPTER (827)

AN **ADAPTER** to use when testing metal tubes in tube testers not fitted for such service is shown. Switches are provided to test each section of dual tubes such as the 5Z4 and 6H6. A chart is fastened to the top of the instrument to show which socket all tubes are to be tested in.

WORLD-WIDE "METAL" RADIO (828)

ELIMINATION of microphonic noise, due to the use of metal tubes is claimed for this new set. A super-power speaker is used, and an automatic tone regulator is provided to give better tonal balance on distant stations. The special "split-second" dial is very accurate and easy to operate. Nine tubes are used, and give outstanding results in sensitivity and tone. Range: 12.5 to 555 meters. (See Fada Data Sheet in this issue.)

BEGINNER'S RADIO SET (829)

(Consolidated Radio Prods. Co.)

THE **BEGINNER** will find, in this all-wave battery set, a foothold in the fascinating game of radio. The coverage is from 15 to 2,000 meters, plug-in coils being employed. A single type 30 tube is used, and a dry cell, with a 22 1/2 V. "B" battery are sufficient in most cases for the power supply.

OIL-FILLED CONDENSERS (830)

(Cornell-Dubilier Corp.)

THESE small oil-filled condensers are rated at 1,000 volts, working, and are made in four capacities, from .05-mf. to 0.5-mf. The size of all types is 2 ins. high and 1 in. square. The units are hermetically sealed.

A.C.-D.C. SIGNAL GENERATOR (831)

(Radio Constructors Labs.)

ACCURACY of 1 per cent is provided by this oscillator. The fundamental range is from 54 to 17,000 kc., but the range can be increased to about 110 mc. by the use of harmonics. Two tubes are used: a 37 rectifier, and a 6C6 oscillator. A neon tube is used as an audio oscillator, if desired.

Below, No. 831. An A.C.-D.C. all-wave signal generator, with a high range. The accuracy is 1 per cent, on the calibrated dial.



Please Say That You Saw It in RADIO-CRAFT

REPLACEMENTS FOR REGULATORS!

There's an **AMPERITE** CURRENT OR VOLTAGE **REGULATOR** for every current or voltage problem ... in any set.

Write for **CHART CV 2**

AMPERITE Co. 561 BROADWAY NEW YORK

Regent 5 Band 15-550 Meter

Switch Receiver



This new improved "Re-Regent" completely eliminates the use of plug-in coils. Independent tuning of the five separate bands is accomplished by means of a five-band switch. No more groping around for the proper coils. A great distance getter that will fulfill the requirements of every fallo experimenter or amateur. Uses 2-58's, 1-80 and 2-2A's. All controls on front of cabinet. Complete kit of parts including speaker, airplane dial, blueprints, and all accessories and cabinet.....\$12.50
Wired and Tested (Extra)..... 2.00
Set of Matched R.C.A. Licensed Tubes..... 2.05
Write for complete circular

TRY-MO RADIO CO., INC.
85 Cortlandt St. New York City
This is our only address

WHEN CHOOSING A RADIO SCHOOL



RCA Institutes, with its reputation established by 26 years service, is an institution recognized as an important factor in the radio industry. Whether elementary radio principles or advanced subjects, sound applications or practical radio engineering, RCA Institutes is prepared to give you the instruction you need.

RESIDENT SCHOOLS NEW YORK AND CHICAGO with modern standard equipment
EXTENSION COURSES FOR HOME STUDY under convenient "no obligation" plan
Illustrated Catalog on Request.

R. C. A. INSTITUTES, Inc. Dept. RT-35
76 Varick St., New York—1154 Merchandise Mart, Chicago

THE R-S SPEAKER SHIMS

Every Service Man should have a set of Speaker Shims for quickly centering voice coils on Dynamic Speakers. Also use our Steel Shims to adjust vibrator points and adjust auto points, etc.

List price per set of Swedish Steel Shims..... 65c.
List price per set of Celluloid shims..... 60c.

Ask for them by name at your jobber's. If he cannot supply you, write us. Send for large circular of other Service Aids.

General Cement Mfg. Co., Rockford, Illinois

Headquarters for Parts-Supplies Since 1923

WHOLESALE PRICES TO THE HOME-SET CONSTRUCTORS EXPERIMENTERS

BLAN, THE RADIO MAN, Inc.
177 Greenwich St., New York, N.Y.
NO CATALOGUE—BUY LOWEST PRICES

30-15,000 CYCLES ± 1 D. B.

Audio Transformers Each Net \$3.75
In Hum-Proof Cases

Single or Push-Pull High and Low Equalizers in Alloy Case.....\$1.50
Hum Proof Alloy Case..... 0.75

ALLOY TRANSFORMER CO., 135R Liberty St., New York City

NEW REFRIGERATION SERVICE MANUAL
If you are interested in servicing electrical refrigerators and component parts, read about the new 1935 OFFICIAL REFRIGERATION SERVICE MANUAL which is now published. Turn to page 229 for complete details.

A PORTABLE-TYPE METAL-TUBE CHECKER

(Continued from page 210)

ation and attractive appearance, while that part containing the test meter is horizontal so as to give full view of the indication to both the customer and the operator. The "free reference point" system permits testing the 6F5 and 5Z4 tubes. The entire new tester may be built complete for less than \$18.00.

A self contained ohmmeter is available with a wide variety of ranges determined by the type of tube that is used in the tester.

Simple continuity testing can readily be made at any distance within vision of the instrument as the sensitive neon light will indicate a closed circuit through 3 megohms. This neon lamp is also used for condenser testing, although the meter is used to advantage in testing electrolytic types and large-capacity mica or paper condensers. Capacities may be approximated.

The panel layout for the tester

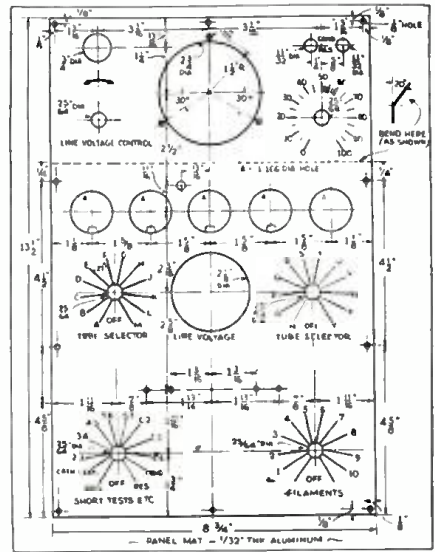

METAL VERSUS GLASS RADIO TUBES

(Continued from page 214)

similar in application to the glass 76 but in this case the amplification factor of the metal tube was raised to approximately 20 for improved operation as an oscillator or voltage amplifier.

6D5—The new metal 6D5 corresponds roughly to the glass 45 in application but, as in the case of the 6C5, the amplification factor is appreciably increased. In addition, the metal 6D5 is a uni-potential cathode-type tube with a 6.3 V. heater. The filament-type cathode used in the 45 is not well adapted to the metal tube design.

6L7—The most noticeable difference between the comparable characteristics of the metal tubes and the glass tubes in modern use appears in the new metal mixer tube, type 6L7. As explained elsewhere in this issue, this pentagrid tube is not intended for use as a combination first-detector and oscillator but rather as an improved mixer working with a separate beat oscillator, such as the 6C5. The advantages gained with the 6L7 include higher gain and greatly improved isolation of the beat oscillator and signal-grid circuits. In addition, the 6L7 can be used as an R.F. amplifier tube with two control grids in operation. This usage results in improved automatic volume control and much better control-grid cut-off characteristics than have been available with glass types heretofore.

Metal tubes have produced new engineering problems both in the design, construction and production of the tubes themselves as well as in the receivers with which they are to function. Many of the constructional changes necessary in receiver design are created by the differences in capacity between similar-type metal and glass tubes. Hence, the comparative capacity data chart—Direct Inter-electrode Capacities—shown on this page will be found invaluable as a reference when experimenting with these tubes.

New 1936 Models
By Triplet



No. 1231

\$26.67 NET DEALER

THE new Triplet Model 1231 is the outstanding All-Wave Signal Generator available to servicemen today. Servicemen need this efficient and reliable unit for checking and aligning RF and IF stages in the latest advanced radio receivers. Built with the traditional Triplet Master Craftsmanship, it is a Master Unit which every serviceman will be proud to own.

FEATURES:

- All frequencies are fundamentals and fully stabilized.
- Has perfect attenuation.
- Special 12" Vernier type direct reading scale permits very accurate readings.
- All parts are low-capacity, non-hydroscopic and thoroughly shielded throughout.
- Six Bands supply frequencies from 100 to 30,000 KC.
- The 6-bands furnish the following frequencies:

100-360 Kc.	3000-9600 Kc.
350-1100 Kc.	9400-18000 Kc.
1050-3200 Kc.	18000-30000 Kc.
- Low-loss switching for band connections.
- Jacks provided on panel for obtaining 400 cycle audio note.
- Has self-contained batteries and two '30 tubes.
- Furnished in regular black Master Unit Case, suitable for inserting in any Triplet Master Carrying Case. Single unit carrying case as shown \$4 net extra.
- Model 1232 is similar to Model 1231, but for 110 volts, 60 cycle A.C. operation.

Dealer's Net Price less carrying case.....\$26.67

- OTHER 1936 TRIPLET MODELS**
- Dealer's Net
- No. 1500 Power Output Tube Tester.....\$36.67
 - No. 1501 Multi-Purpose Tube Tester—(10 units in 1)..... 46.67
 - No. 1206 Master 1936 Test Set..... 82.67
 - No. 150 Decibel Meter Kit..... 21.67
 - No. 200 Decibel Meter Kit..... 23.50
- You will want to know more about these new 1936 Triplet instruments, so contact your jobbers regularly and write for new price sheets.

TRIPLET ELECTRICAL INSTRUMENT CO.
178 Main St. Bluffton, Ohio, U.S.A.

TRIPLET ELECTRICAL INSTRUMENT CO.
178 Main St., Bluffton, Ohio, U.S.A.

Please rush to me at once catalog on the new line of Triplet instruments and testers.

Name.....
Street.....
Town..... State.....

Please Say That You Saw It in RADIO-CRAFT

BIZ ON THE BUM, NO WONDER I'M GLUM, NO SETS TO SERVICE, SURE HAS ME NERVOUS!

PSST! MR. SERVICE MAN, I'M NATIONAL UNION'S PLAN; GET ALL THE DOPE ON ME, I'LL HELP YOU, YOU WILL SEE!

I DID BOYS, AND NOW I'VE FOUND OUT HOW TO GET JOBS AND HANDLE THEM RIGHT!

SEND THE SLIP HERE BELOW, IF YOU TOO WANT TO KNOW... WHY NATIONAL UNION MEANS MORE THAN RADIO TUBES

National Union Radio Corporation of N. Y.
570 Lexington Ave., New York, N. Y.
RC-1035

Tell me how to get radio service shop equipment Free on the National Union plan.

Name _____

Street _____

City _____ State _____



Dependable

Insulated carbon resistors in all standard sizes, 5% or 10% tolerances. Send for Bulletins 101 and 102, Free.

CONTINENTAL CARBON Inc.

13914 Lorain Ave., Cleveland, Ohio.

PRECISION Capacitor Analyzer

Type CA-1
110 volts—60 cycles

Utilizing the Wien Bridge method, with 8 outstanding features. Compact, easy to use, thoroughly dependable. Reasonably priced.



Send for Complete Literature



SOLAR MFG. CORP.
599-601 Broadway, New York City

THE "METAL-GLASS" CONVERTER TUBE IN ALL-WAVE SETS

(Continued from page 211)

conditions, are not readily recognized by any of the ordinary plate current, screen-grid current, or mutual conductance readings, the changes made in the Triad 2A7 and 6A7 tubes will not make much difference in any tube tester readings. In like manner, measurements made on the 6A7 while oscillating, usually will not indicate whether or not any given tube will cause circuit oscillation in a short-wave receiver.

When the metal tubes were first announced and it was decided to develop the MG ("metal-glass") series of tubes, the advantages of the improved 6A7 tubes were kept in the 6A8 MG in that exactly the same grids, plate, cathode, and other parts were used even to the carbon spray on the bulb. In this way, all the electrical data for the 6A7 is true for the 6A8-MG.

In Fig. 1 a schematic diagram of a 6A8 oscillator, Rp and Rg, shown in dotted lines, represent the oscillator anode resistance and effective grid resistance respectively, of the tube. Ro represents the total effective resistance of the losses in the oscillator coil and condenser in parallel with the grilleleak. Rb represents the plate voltage dropping resistor. T is the turns ratio of the transformer. An analysis of this circuit will yield the following equation, assuming tight coupling between the coils, which must be satisfied if the circuit is to oscillate.

$$G_m > \frac{T}{R_p} + \frac{R_g + R_o}{T^2 R_g R_o}$$

Thus, it is seen that a high Gm between oscillator grid and plate, a high plate resistance (Rp), and a high effective grid resistance (Rg) favor oscillation. Of course, these dynamic figures must be measured at the bias conditions indicated in the circuit, and with a very small A.C. voltage. A grilleleak of 50,000 ohms and a dropping resistor of 20,000 ohms are typical bias resistors with a 250 V. plate supply. The average plate resistance of the 6A8-MG is the same as the average of other manufacturers. The Gm is higher than in the original A7 converters and is held more uniform by rigid factory test limits. The value of Rg, the effective grid resistance before oscillation has started, is dependent almost entirely upon the contact potential of the oscillator grid since a greater grid current will flow through Ro with a greater contact potential and thus produce a lower Rg.

The tube characteristics discussed so far as factors determining whether or not the circuit will oscillate, are not functions of frequency, and thus do not account for the fact that most any 6A8 will oscillate at the high-frequency end of a waveband, but will not start oscillating at the low-frequency end. It will be remembered that Ro in the schematic diagram, represents the grilleleak resistance and also the effective resistance of the tuning circuit. Since the tuning circuit has a lower "Q" and greater losses at the lower-frequency end of a band, the effective resistance of the circuit is much lower. In this way, Ro, the grilleleak resistance, in parallel with the tuning circuit resistance, is lower. It is obvious from the equation of oscillation that a low value of Ro will restrict oscillation exactly as a low value of Rg.

SHORT-CUTS IN RADIO

(Continued from page 222)

would not oscillate below 40 meters, due to the solid coil forms used. They were then drilled and cut out as shown in the drawing, leaving a form with 8 ribs. This so improved the performance of the receiver that the circuit now oscillates down to 5 meters! (Fig. 9.)

R. C. CIESICKI

HONORABLE MENTION

POINTER KNOBS. The pointer-type knobs often are difficult to re-set because they are so blunt on the end. A piece of safety pin can be inserted in the end of the pointer as shown in the drawing, making it easy to exactly re-set the pointer. The slot is cut with a hacksaw blade, the blade being turned sideways at the bottom of the slot to make it wedge shaped. The piece of pin is simply snapped in place. (Fig. 10.)

RICHARD U. RUNYAN

Please Say That You Saw It in RADIO-CRAFT

HANDY Electric PAINT SPRAYER

ONLY \$14.50 Complete Outfit and Spray Gun

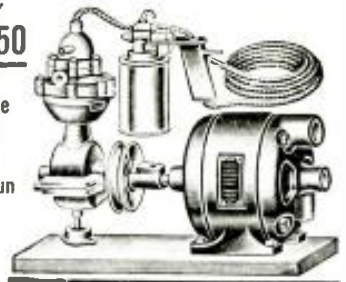

Starting after! Famous spraying outfit includes pressure lateral spray gun, adjustable, non-clogging, fan and round spray nozzles. Ideal for spraying paint, varnish, enamel, lacquer, shoe dyes, disinfectant, water, insecticides, etc. The power was never more useful than when better work. Great complete with spray gun, National Compressor with sealed piston (leakage-free) heavy duty Westinghouse motor, 110 and 60 cycle, A.C. plug and cord, motor also 1/2 hp. Just plug into high socket and it is ready for operation. \$14.50 complete. Send \$5.00 deposit. Balance \$9.50. Total net weight, 30 lbs. Sold on money-back guarantee basis.

WELLWORTH TRADING COMPANY
560 W. Washington Blvd. Chicago, Ill.

WELLWORTH TRADING COMPANY RC-1035
560 W. Washington Blvd., Chicago, Ill.

Enclosed you will find my remittance of \$14.50 for which please send me

- Electric Paint Sprayer, by Express collect.
- Or \$3.00 deposit, with balance C. O. D.

Name _____

Address _____

City _____ State _____

CLASSIFIED ADVERTISEMENTS

Advertisements in this section are inserted at the cost of twelve cents per word for each insertion—name, initials and address each count as one word. Each should accompany all classified advertisements unless stated by a recognized advertising agency. No less than ten words are accepted. Advertising for the November, 1935, issue should be received not later than September 3th.

A.C. AUTO GENERATORS

TWENTY NEW PRACTICAL CHANGES FOR AUTO-mobile generators. See our advertisement at bottom of page 17, Auto Power Inc.

ELECTRICAL SUPPLIES

INSULATION, WIRE, VARNISHES, SUPPLIES, ETC. Send for stamp or bulletin. Auto Power, 411-C S. Hoyne Ave., Chicago.

PATENT ATTORNEYS

PATENTING INVENTIONS IS MY SPECIALTY through 28 years; Sterling Buck, Registered Patent Attorney 7750, 629 F. Washington, D.C. (Free Bulletin-R)

RADIO

RADIO ENGINEERING, BROADCASTING, AVIATION and 1011 radio, servicing Marine and Morse Telegraphy fan, thoroughly. All expenses low. Catalog free. Dodge's Institute, Pine Street, Valparaiso, Indiana.

SOUND EQUIPMENT

USED SOUND EQUIPMENT. DUPONT SYSTEMS, 3970 Archer Avenue, Chicago, Illinois.

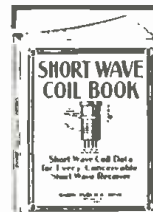

Every SHORT-WAVE SET-BUILDER NEEDS THIS BOOK

Every experimenter who has ever tried to build a short wave set knows by experience, the difference between a good set and a poor receiver is usually found in the short wave coils. Often you have to hunt through magazine books, etc., to find the information you require. The present book has been gotten up to obviate these difficulties.

In this book you find every possible bit of information on coil winding. Only the most modern "tips" have been published. Illustrations abound, giving not only full instructions on how to wind coils, but dimensions, size of wire, curves, how to plot them, by means of which any coil for any particular short wave set can be figured in advance, as to number of turns, size of wire, spacing, etc. There has never been such data published in such easy accessible form as this.

Send me your money receipt of

25c

in full or 50% of U.S. postage stamps

RADIO PUBLICATIONS,

101C Hudson St., New York, N. Y.



BUILD this 10-tube Professional Superhet and save over 50%

SILVER
HIGH-FREQUENCY SUPERHETERODYNE

HERE'S the latest and hottest in high-frequency superhets—one that you can assemble, test and align in one evening at home. It's designed by McMurdo Silver, Frank Jones and fit on leading manufacturers—and it brings you

- Two tuned r. f. stages on all four bands.
- Ten Raytheon tubes
- Four low-C tuning bands, 1500 to 33,000 kc. (9 to 200 meters).
- Ample Crowe band spread tuning anywhere in its range.
- Biley crystal single signal filter that doesn't cut volume.
- All Chitran A. C. operated—one unit—no hum.
- 8-inch Jensen speaker—and phone jack.
- Polished chromium welded chassis.
- Air-tuned Polytiron i. f. transformers.
- Separate r. f. coils positively switched for each band—all Hammarlund air trimmed.
- Sensitivity 1 microvolt absolute.
- Selectivity—variable 150 cycle to 10 kc.
- Amplified automatic volume control.
- No inherent circuit or tube noise.
- Wired with made-up color coded cable requires no circuit tracing, or even a diagram.

START FOR AS LITTLE AS \$7.30 BUY THE PARTS AS YOU BUILD!

Now is time to get ready for the new DX season. The 32-page "HOW TO BUILD IT" Book sent for 10c, stamps or coin, tells the whole story of 1935's outstanding communication receiver. You can build and align it in a few hours... or you can buy its standard parts from your local jobber as you build if you haven't already got many of them.

SEND 10c
for
32-page book
"HOW TO BUILD IT"

SPONSORED BY:

- Biley Piezo Electric Co., Crowe Name Plate and Mfg. Co., Hammarlund Mfg. Co., Chicago Transformer Corp., Yaxley Div. of P. R. Mallory Co., Jensen Radio Mfg. Co., Sprague Products Co., Continental Carbon Co., Ohmite Mfg. Co., Resistor Meter Works, Raytheon Production Corp., Aladin Radio Industries, Inc., Steel Box & Mfg. Co., Ethernatic Mfg. Co., McMurdo Silver Corp.

Address:
R-S MERCHANDISING COMMITTEE
1709 Roscoe St., Chicago, Ill., U. S. A.

AMPERITE
HIGH LEVEL VELOCITY
(HIGH IMPEDANCE 2000 OHMS)

OPERATES WITHOUT PRE-AMP

ELIMINATES HUM TROUBLE

THIS MICROPHONE IS HIGH ENOUGH IN IMPEDANCE TO OPERATE DIRECTLY INTO GRID BUT NOT HIGH ENOUGH (ONLY 2000 OHMS) TO INTRODUCE SERIOUS LOSSES IN LINE UP TO 200.

Requires no pre-amp when used with regular high gain amplifier (100 DB). Replaces condenser and crystal microphones—NO CHANGES or additions necessary! **ELIMINATES INPUT TRANSFORMER** and its losses. Therefore requires 12 db less over-all amplification. Eliminates inductive hum. **NO FEEDBACK.**

LIFELIKE BRILLIANCE
The High Level Velocity reproduces both speech and music with their original brilliance. Also excellent on crosse talking.

MODEL RB-H. for speech and music LIST \$42.00 with coupling
RS-H. for speech, can also be used for music LIST \$32.00 with coupling

Write For Bulletin HL
561 BROADWAY NEW YORK

AMPERITE Company
AMPERITE 1 POINT VELOCITY MICROPHONE

We SPECIALIZE in the Design and Manufacture of Public Address Amplifiers

SEND FOR FREE CATALOG!
Number K-30

Describes in detail 86 different models and complete P.A. Systems ranging up to 200 audio watts output, 6 volt; AC; DC.

Buy Direct from Manufacturer AND SAVE BIG MONEY
Coast to Coast Radio Corp.
559-R Sixth Ave. New York, N. Y.

THE SWEEP VOLTAGE FOR CATHODE-RAY TUBES

(Continued from page 213)

up and down vertically in synchronism with its variations in intensity, and the spot of light will trace a *straight vertical line* on the screen. It is evident that if the exact *curved wave form* of this voltage is to be traced, some means must be provided for shifting the beam *simultaneously* in a horizontal direction while it is being moved up and down vertically by the voltage to be observed, so that the trace will be spread out.

Let us now consider the type of voltage that must be applied to the vertical deflecting plate; for "sweeping" the beam horizontally, or "timing" it. This is commonly known as the *sweep* or *timing* voltage. From what has already been said, it will be realized that the voltage used should be a repeating or "recurrent" one. Furthermore, for most purposes it is preferable that it be one, which, when applied to the vertical plates will deflect the beam so that the spot of light is shifted *uniformly*, say, from left to right with an *abrupt* return from right to left, the return occurring in only a small fraction of the time taken to travel from left to right (so that the return may be considered as being practically instantaneous). If a voltage which varies in this way is plotted against time, the wave form is of the type shown at B of Fig. 1. Because its shape resembles the tooth of a saw, it is commonly referred to as a *saw-tooth* voltage.

The frequency of the saw-tooth voltage applied must have a definite relationship to the frequency of the voltage which is to be observed. For example, to examine one cycle of it, the saw-tooth voltage must be of exactly the same frequency as that of the voltage to be observed, since the timing voltage must be ready to shift the spot of light back just at the instant that each cycle of the voltage being observed is completed. This condition is shown in A and B of Fig. 1. If two cycles of the voltage being observed are to appear on the screen at one time, then it must go through two cycles before the timing voltage shifts the spot back to the starting position, i.e., before the timing voltage has completed one cycle. This is shown at D and E of Fig. 1. The wave pattern (2 cycles) which will appear is shown at F.

There are several ways of generating a saw-tooth sweep voltage of the wave form shown in Fig. 1. Whatever develops it must be designed to generate a voltage which will increase uniformly to a certain value, then drop abruptly to zero, and repeat itself.

There are a number of electrical "sweep circuits" which may be employed for this purpose. A typical, simple circuit of this kind, which employs a type 885 thyratron tube is shown in Fig. 2.

The thyratron tube employed contains the cathode, grid and plate, as shown. Since it also contains gas, it is a tube capable of exerting a "trigger" action in the circuit. When normal grid-bias voltage is supplied to it, no current will flow through the tube unless the voltage applied to its plate is made high enough to ionize the gas in the tube (300 V. in this case). If this happens, the ionization of the gas causes the tube to break down immediately, the resistance of the path between the plate and cathode suddenly becomes very low, and the grid loses all control of the plate current.

Now let us see how this tube operates in the sweep-voltage circuit of Fig. 2. The 630 mmf. plate-cathode condenser is charged by the plate supply voltage through resistors R1 and R2. The grid-bias voltage of the tube (resistor R3 supplies it) prevents plate current flow through the tube until the voltage across this condenser builds up to the breakdown value of the tube (300 V. in this case). The flow of the current into the condenser during this interval is shown in the simplified diagram at A of Fig. 3.

Another form of sweep circuit which may be used, is shown in Fig. 4. This is a motor-driven type. A motor whose speed may be controlled very accurately is geared to the arm of a potentiometer, R, connected across a battery. As the arm of the potentiometer (which we will assume is rotating counter-clockwise) turns from A to B the voltage tapped off increases *uniformly* from zero to the full value of the battery. At point B the contact is broken, so the current drops quickly to zero and remains at zero until the arm reaches point A where contact is re-established and the cycle is repeated over again.

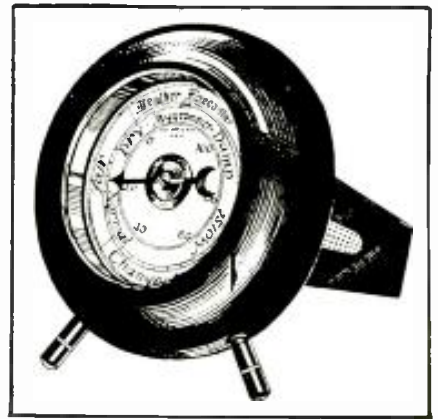

Something NEW!

Weather Forecaster and Humidity Tester

"HYGROSCOPE"

The Ace of Weather Forecasters

When placed in a well-ventilated room or in the fresh air, the HYGROSCOPE foretells coming weather conditions from eight to twenty-four hours in advance. It also accurately records outdoor humidity, and when placed inside it gives the humidity within the house or room.

The HYGROSCOPE is automatic, self-adjustable, simple American-precision made. It cannot get out of order at any time. The dial measures 2 1/4" is enclosed in a 6" round hardwood case, with either walnut or mahogany finish. It is attractive for desk or living room.

OUTSIDE DIAL FORECASTS WEATHER

Fair—rain—or changeable is indicated on the outer dial when the HYGROSCOPE is placed in a well ventilated room or out-of-doors. If indoors, place the instrument near an open window.

INNER DIAL SHOWS THE HUMIDITY CONTENT

The HYGROSCOPE also acts as a hygrometer. Numbers on the inner dial indicate the degree of humidity present in the air and in artificially heated rooms.

SEND YOUR ORDER NOW! Get your HYGROSCOPE today. Your remittance in form of check or money order accepted. If you send cash or unused U.S. Postage Stamps, be sure to register your letter. Also specify if you prefer the HYGROSCOPE in Walnut or Mahogany. All orders are shipped immediately. **\$2.00** POSTPAID

MAIL THE COUPON BELOW!

GREN PARK COMPANY
99 Hudson St. New York, N. Y.

GREN PARK COMPANY RC-1035
99 Hudson Street, New York, N. Y.

Enclosed you will find my remittance of \$... for which send me at once, POSTAGE PREPAID, ... HYGROSCOPES at Two Dollars each.

Walnut Model Mahogany Model

Name

Address

City State

(Send your remittance in check or money order. If your letter contains cash or unused U. S. Postage Stamps, be sure you register it.)

BARGAIN! 7-TUBE CHASSIS

With 11 Inch Dynamic Speaker

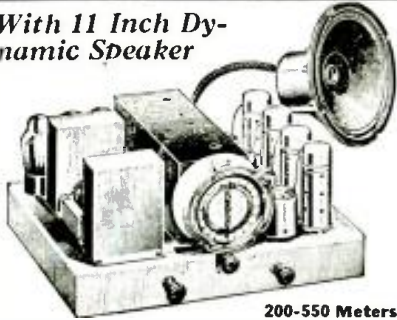

200-550 Meters

Not a Midget!—but a full-sized console chassis

Uses 4-58's, 2-2A5's in parallel and a type 80 full wave rectifier all arranged in a sensitive T.K.F. circuit. Has large, illuminated surface dial, tone control, provisions for phonograph attachment and full, 11" dynamic speaker. 4 tuned stages make for extreme sensitivity and exceptional selectivity. Only material of the highest quality is used in its construction. Undistorted output of better than 6 watts—enough power to operate four additional dynamic speakers. Resistance coupling is used throughout which means that radio programs are reproduced with exceptional fidelity of tone.

Limited quantity, hence, "first come, first served." Overall size 16x12x7 1/2". Ship. wt. 35 lbs. List price \$75.00

No. 643 7-tube TRI chassis including dynamic speaker, but less tubes. **\$16.53** Less Tubes
Your Price Complete set of tubes \$3.65
See page 252 for our other advertisement.

RADIO TRADING CO.
37 Hudson St. N.Y.C.

G. E. MOTORS

These motors were manufactured by the General Electric Company and originally intended for use by a large manufacturing company.

Here are the specifications: 1 3/4 h.p. 4800 R.P.M. Universal A.C. and D.C. 110 volts instant reverse. Size: Diameter 3 inch, length 5 inch.

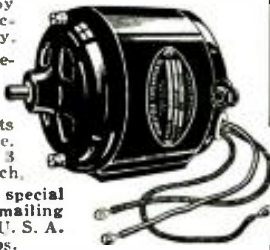

Add 25c for special packing and mailing anywhere in U.S.A. Ship. Wght. 3 lbs.

\$2.45 Each DO NOT WRITE FOR CATALOG

WELLWORTH TRADING CO. RC-1035
558 W. Washington St., CHICAGO, ILL.
Enclosed find \$ for which ship:
 G. E. Motor @ \$2.70 each (Prepaid in U.S.A.)

Name _____
Address _____
City _____ State _____

BUILD IT YOURSELF

You can build this Trailer with ordinary tools easily from our step-by-step constructional sheets and large sized blueprints. Finest 4-wheeled Trailer in existence, steps 4, Toilet, Shower, Electric Light, etc. Save 75% of the cost by building it yourself. Send 25c for plans sheet, illustrations and details. **THE PLAN SHOP, 910 Palmolive Bldg., Chicago, Ill.**

RADIOS..SAVE UP TO 50%

DEAL DIRECT: Factory Price. Many models in stock from A.C. D.C. All waves. Ear. Case and new metal Tube. Make Your name and address on postcard blank you NEW 28 page 1935 Bargain Catalog in colors FREE. Get details of 30 DAY TRIAL plan and terms. For proposition. Goldentone Radio Co., Dept. 202, 8780 Grand River, Detroit, Mich. **Free Catalog** **30 DAY TRIAL \$6.98**

HOW TO MAKE AN "EIR" TESTER

(Continued from page 218)

meter.

It is interesting to note that in case of damage to the rectifier by overload which does not exceed 25 per cent, calibration of the instrument may be restored by removing the compensator spool and replacing it with another, which corrects calibration. Furthermore should the rectifier be entirely destroyed by excessive overload, the whole rectifier panel may be removed and replaced with another and since the meters and rectifier panels are standardized, the calibration will be exact with the new panel.

CONSTRUCTION

The construction of this meter is quite simple and if the panel is obtained drilled and engraved, the total time necessary for the assembly should be less than an hour and a half.

The photo showing the back of the meter indicates the simplicity of the wiring. Use at least a No. 14 medium hard-drawn, tinned, copper wire, particularly when current circuits are involved. This will minimize the error in reading high current ranges.

CHECKING FOR ACCURACY

After the meter has been wired and all circuits checked with the diagram of Fig. 1, the builder is then ready to check out the various ranges for accuracy. If a radio set is available, for example with 2 1/2 V. A.C. tubes, select the 5 volt scale of the meter, throw the switch in the A.C. position, and read the A.C. voltage. The voltage should read, of course, approximately 2 1/2 V. Draw the plug from the 5 V. scale and plug it into the 10 V. scale. Check the accuracy of the reading there. Check the high ranges. It may be necessary to measure three potentials, always starting with the lowest possible range, and checking through the readings on the higher ranges. In this way it is quite possible to check all of the A.C. and D.C. voltage scales without difficulty. In checking the milliamper scale, it would be wise to select the plate circuit of some tube, particularly in the radio-frequency portion of the receiver. Note the plate current on the 10 ma. scale, having the A.C.-D.C. switch in the D.C. position, by the way. Then take the same current on the 25 ma. scale. Go to a power tube circuit and check the 100 ma. scale and use the same circuit for reading on the 500 ma. scale. (Continued on page 248)

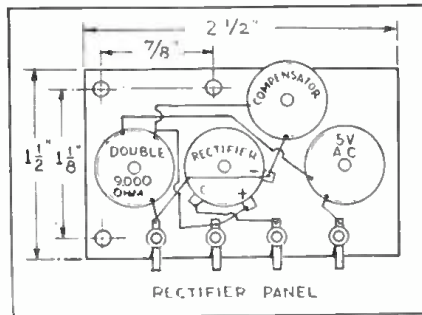

Fig. 2, above. The rectifier panel connections.

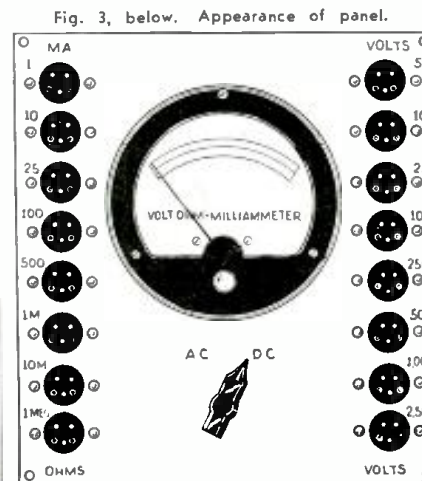

Fig. 3, below. Appearance of panel.

Do You HANDLE TOUGH PROBLEMS?

THIS **TRIUMPH** DOES **SIGNAL GENERATOR**



1000 sets a day on production or 5 a week on the service bench prove it

"EASILY SUPERIOR"

NO CHARTS—JUST DIAL **\$29.94** Net
Model 110 A.C. or 150 Battery Type.

The Model 300 Multirange Meter

Measures Output Resistance D.C. Volts A.C. Volts Milliampers With 11 Ranges

\$19.95 Net



TRIUMPH—"The Guarantee of Excellence." Designers and manufacturers of testing equipment only.

FLASH—A million OCTAL TUBES now in use—TRIUMPH Model 400 tests them all—WITHOUT ADAPTERS.

TRIUMPH MFG. CO., 4019 W. LAKE ST., CHICAGO

Gentlemen: Please send me your literature on
 Signal Generators Meters
 Tube Testers Analysers

NAME _____
ADDRESS _____
CITY _____ STATE _____

Sensational
NEW
INSULATED
Metallized **RESISTORS**
IRC

Radio's most important resistor development! Insulated against shorting—humidity, stress breakage. Famous Metallized resistance principle. See them at your jobbers. Write for catalog.

International Resistance Co.
Toronto, Canada Philadelphia, Pa.

COMPLETE DESIGNS of 10 Public Address AMPLIFIERS

A manual of circuits of Audio Amplifiers. One for every purpose. From 3 watts to 30 watts. All tried and tested designs. With complete lists of parts and their values.



FREE!

VALUABLE REFERENCE BOOK. This advertisement and 10c INSTAMPS, to cover mailing expenses, will bring you **FREE** copy of this valuable Reference Book. There is no obligation.



STANDARD TRANSFORMER CORPORATION
851 Blackhawk St., Chicago

TUBE PRICES REDUCED!

ARCO Tubes—Guaranteed 6 Months—Licensed by R. C. A.—All prices F. O. B. factory, Newark, N. J. Orders for less than \$3.00 not accepted. 25¢ deposit required on all orders.

METAL SHIELDED TUBES

Type	Price	Type	Price	Type	Price
6K7	\$.99	6H6	\$.89	6F5	\$.89
6A8	1.09	5Z4	1.29	25Z5-MG	1.05
6I7	.99	6F6	1.05	43-MG	1.09
6CS	.89	6L7	1.09	Ballast Unit	.65

REGULAR TUBES

Your Cost	Your Cost	Your Cost	Your Cost	Your Cost	Your Cost
.26c	.31c	.40c	.44c	.56c	.68c
.90c	\$1.13				

Type	Type	Type	Type	Type	Type	Type	Type
01A	12A	24A	19	00A	83V	10	48
25	27	35	51	20	1V	1C6	81
80	30	36	33	22	6F7	12A5	2B6
	31	38	42	32	PZH	12A7	586
	37	39	43	34	182B	401	403
	40	41	46	53	183		BI1
	45	44	49	59	484		
	56	47	55	79	485		
	71A	57	75	84	636		
	76	58	77	99	Std		
		82	78	WD11			
		83	85	WD12			
		5Z3	89	1A6			
		6D6	98V	2A3			
			99X	2A7			
			2A5	2B7			
			2A6	6A4(1a)			
			6C6	6A6			
			12Z3	6A7			
			25Z5	6B7			
				6Z4(84)			

MAJESTIC TYPE TUBES

Type	Your Cost	Type	Your Cost	Type	Your Cost
2A7S	\$1.01	6D7	\$0.79	55S	\$0.77
2B7S	1.01	6E7	.79	27S	.36
25-4S	1.19	6F7S	.86	35S-51S	.63
22Z-684	.83	6Y5	.86	56S	.59
6A7S	1.04	6Z4	.59	57S	.79
6I7S	.95	6Z5	.86	58S	.79
6C7	.86	25-25S	.59	75S	.77
			1.22	85S	.77

Questions on Transmitting Tubes, Television Tubes, Charger Bulbs, Photo Cells, Croton Tubes, Cathode Ray Tubes, sent upon request.

ARCO TUBE CO. 232 CENTRAL AVENUE, NEWARK, NEW JERSEY

BUY THESE Great Books!

Chirardi's MODERN RADIO SERVICING
Chirardi and Freed's RADIO FIELD SERVICE DATA
Send for FREE CIRCULAR today!
RADIO & TECHNICAL PUBL. CO., 45 Astor Place, Dept. RC-10, New York City

HOW TO MAKE AN "EIR" TESTER

(Continued from page 247)

OTHER USES

While the meter was primarily designed for the measurement of voltage, resistance, and current, other uses indicate themselves to those familiar with such equipment. For example, the meter can be used as a decibel meter where 1.73 volts on the 5 volt scale would be equivalent to the level of .006-W. on a 500 ohm line.

LIST OF PARTS

- One Hickock Model 49X meter, 50 mv. drop, with M rectifier panel;
- One ICA drilled and engraved metal panel;
- Sixteen three contact sockets;
- One plug;
- One ICA small bar knob;
- One pair ICA test leads;
- One three-circuit, two-position switch, Sw;
- One Electrad 20 ohm potentiometer, shaft slotted for screwdriver adjustment, R5;
- One Electrad 100 ohm potentiometer, shaft slotted for screwdriver adjustment, R7;
- One Electrad 2,500 ohm potentiometer, shaft slotted for screwdriver adjustment, R9;
- One Electrad 100 ohm flexible resistor, R6;
- One Electrad 13,500 ohm resistor, R8;
- Four meter shunts for 10, 25, 100 and 500 ma., R1, R2, R3, R1;
- One Shalleross resistor, 4,950 ohms, R10;
- One Shalleross resistor, 5,000 ohms, R11;
- One Shalleross resistor, 20,000 ohms, R12;
- One Shalleross resistor, 95,000 ohms, R13;
- One Shalleross resistor, .245-meg., R14;
- One Shalleross resistor, .495-meg., R15;
- One Shalleross resistor, 0.5-meg., R16;
- Two Shalleross resistors, 0.75-meg., R17, R18;
- One carrying case.
- One aluminum bracket.
- One 1.5 V. flashlight cell, tubular type, B1;
- Two "C" batteries, B2, B3.

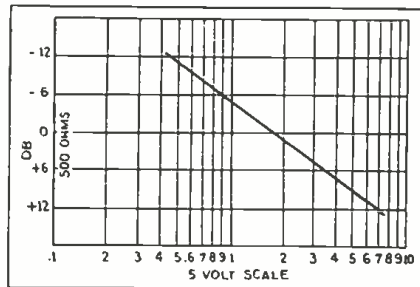

Fig. 4. Decibel graph for the meter.

MAKING THE LAZYMAN "4"

(Continued from page 205)

LIST OF PARTS

- One Eagle dynamic speaker;
- One Eagle 2-gang tuning condenser, Cx;
- One Eagle set of coils, L1, L2;
- Four Eby metal tube sockets, V1, V2, V3, V4;
- One Eagle filter choke, 15 hy., 300 ohms, Ch.;
- One Eagle 50,000 ohm volume control, R;
- Six Solar double padding condensers, C1-4 to 25 mmf., C2-40 to 70 mmf., C3-50 to 100 mmf., C1-60 to 110 mmf., C5-60 to 220 mmf., C6-200 to 400 mmf.;
- Seven Wholesale Radio Co. D.P.S.T. switches, Sw. 1, 2, 3, 4, 5, 6;
- One Eagle double electrolytic cond., 8-16 mf.;
- One Eagle resistor, 200 ohms, 1 W.;
- One Eagle resistor, 20,000 ohms, 1 W.;
- One Eagle resistor, 800 ohms, 1 W.;
- Two Eagle resistors, .5-meg. each, 1 W.;
- One Eagle condenser, .002-mf., 200 V.;
- One Eagle condenser, .006-mf., 200 V.;
- One Eagle condenser, .05-mf., 200 V.;
- Two Eagle condensers, 0.1-mf. each, 200 V.;
- One Eagle condenser 5 mf., 200 V.;
- One Eagle condenser, 0.5-mf., 200 V.;
- One Eagle midjet-set chassis and cabinet;
- One Triad type 6J7-MG tube;
- One Triad type 6K7-MG tube;
- One Triad type 43-MG tube;
- One Triad type 25Z5-MG tube;
- One Eagle 160 ohm power line cord;
- Wire, misc. hardware, etc.

- - a new magazine for short-wave fans! SHORT WAVE LISTENER



4,600 Short Wave stations listed

THE finest magazine of its kind ever published—totally different in set-up and contents from any other, contains the latest listing of short wave stations in the world, up-to-the-minute. Including "Police," "Television" and short-wave stations, as well as a special list of the star short-wave stations with their frequencies and call letters. Also contains photos and descriptions of short-wave broadcasting stations in various parts of the world with photos of short wave studio artists.

25c THE COPY

—How to locate "weak" distance stations, and other hints for the "short-wave listener"—Question and Answer Department for the "Listener" Silver Cup Trophy for best photo of listening "Posit".

SHORT WAVE LISTENER
ON ALL NEWSSTANDS 99 Hudson St. New York, N. Y.

Most Amazing TYPEWRITER BARGAIN

10 DAY FREE TRIAL OFFER EVER OFFERED



NEW REMINGTON PORTABLE only 10c A DAY

FIRST TIME! Remington's new purchase plan now lets you buy a genuine latest model Remington Portable No. 5 direct from the factory for only 10¢ a day. Not used or rebuilt. Not incomplete. A beautiful brand new regulation Remington Portable. Standard 4-row keyboard, standard width carriage, margin release on keyboard, back spacer, automatic ribbon reverse; every essential feature found in standard typewriters.

With your initial purchase we send you free a 19-page course in typewriting. Teachestouch system quickly, easily. Soon you dash off letters quicker than with pen and ink. You also get a handsome, sturdy carrying case free.

FREE Typewriting Course

BIG PRICE REDUCTION



The amazing low price and easy terms now make it possible for you to buy this genuine complete Remington Portable for only 10¢ a day. But we cannot guarantee present prices long. Higher wage scales, rising cost of materials, everything points to higher prices. So we say, "Act now," while our liberal offer still holds good!

FREE Carrying Case

You Don't Risk One Cent

Try this typewriter in your home or office on our 10-day FREE TRIAL OFFER. Then, if you do not agree that it is the finest portable at any price, return it at our expense. You don't even risk shipping charges. Don't wait. Mail coupon now. It's the best chance you've ever had to own so complete a machine for so little money. So act NOW!

CLIP COUPON NOW

Remington Rand, Inc., Dept. 189-10
205 East 42nd St., New York City

Please tell me how I can buy a new Remington Portable typewriter for only 10¢ a day. Also enclose your new catalog.

Name _____
Address _____
City _____ State _____

Please Say That You Saw It in RADIO-CRAFT

Just Out!

THESE TWO NEW BOOKS

10 CENTS

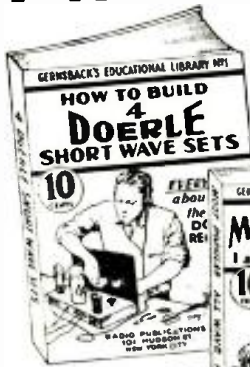

Each book contains 32 pages—and is well illustrated.

LITERALLY thousands of radio fans have built the famous DOERLE Short Wave Radio Receivers. So insistent has been the demand for these receivers, as well as construction details, that this book has been specially published.

HOW TO MAKE FOUR DOERLE SHORT WAVE SETS

Contains EVERYTHING that has ever been printed on these famous receivers. These are the famous sets that appeared in the following issues of SHORT WAVE CRAFT: "A 2-Tube Receiver that Reaches the 12,500 Mc. Mark," by Walter C. Doerle (Dec., 1931-Jan., 1932); "A 3-Tube Signal Gripper," by Walter C. Doerle (November 1932); "Doerle's 2-Tube" Adapted to A. C. Operation" (July 1933); "The Doerle 3-Tube Signal-Gripper" Illustrated" (August 1933) and "The Doerle Goes 'Broad-Spread'" (May, 1934).

Due to a special arrangement with SHORT WAVE CRAFT, we present a complete 32-page book with stiff covers, printed on an extra heavy grade of paper with numerous illustrations. Nothing has been left out. Not only are all the DOERLE sets in this book, but an excellent power book. If you wish to electrify any of the DOERLE sets, is also described.

HOW TO MAKE THE MOST POPULAR ALL-WAVE 1- and 2-TUBE RECEIVERS

THERE has been a continuous demand right along for a low-priced book for the radio experimenter, radio fan, radio Service Man, etc., who wishes to build 1- and 2-tube all-wave sets powerful enough to operate a loud-speaker. For the thousands of readers who wish to build such sets, this book has been especially published.

This book contains a number of excellent sets, some of which have appeared in past issues of RADIO-CRAFT. These sets are not toys but have been carefully engineered. They are not experiments. To mention only a few of the sets, the following will give you an idea:
 • The Mealyne 1-Tube Pentode Loud-speaker Set, by Hugo Gernsback. • Electrify! The Mealyne. • How To Make a 1-Tube Loud-speaker Set, by W. P. Chesney. • How To Make a Simple 1-Tube All-Wave Electric Set, by W. Green. • How To Build a Four-In-Two All-Wave Electric Set, by J. T. Bentsley, and others.
 Not only are all of the illustrations, lookups, etc.—the book, in fact, contains everything. Nothing at all has been left out.

And believe it or not, each book contains over 15,000 words of new legible type. Each book is thoroughly modern and up-to-date. They are not just a reprint of what was printed before. All the latest improvements have been incorporated into the sets.

Remember, these books sell at the extraordinary low price of 10 cents; you can not possibly go wrong in buying them. Despite its low cost, our usual guarantee goes with this book as well!

IF YOU DO NOT THINK THAT THIS BOOK IS WORTH THE MONEY ASKED FOR IT, RETURN IT WITHIN TWENTY-FOUR HOURS AND YOUR MONEY WILL BE INSTANTLY REFUNDED.



There has never been such a wealth of data published in a low-priced radio book of this type in the history of the radio publishing business.

Take advantage of the special offer we are making and use the coupon below.

RADIO PUBLICATIONS
103 Hudson Street
New York, N. Y.

RADIO PUBLICATIONS RC-10-35
103 Hudson Street
New York, N. Y.

- Please send immediately books checked:
 How to Build Four Doerle Short-Wave Sets.....10c
 How to Make the Most Popular All-Wave 1- and 2-Tube Receivers.....10c
 I am enclosing \$_____ (at the price of each book is 10c, 10c or U.S. Stamps acceptable.) Books are sent post-paid.

Name _____
 Address _____
 City _____ State _____

Please Say That You Saw It in RADIO-CRAFT

THE "NEON" INTERFERENCE PROBLEM

(Continued from page 219)

from either a defective secondary coil, pick-up from secondary wiring, pick-up from tubes, partial ground or short in secondary wiring, pick-up from back bends in tubing caused by difference in potential in these sections of glass, pick-up from suspension wires from which window signs are hung, or pick-up from metallic objects, such as metal ceiling, pipes, and so forth, in the immediate vicinity of the sign. The solution here is to ground out, or neutralize all points of possible pick-up. I suggest that the Service Man proceed as follows: always remembering that he is working on a simple electrical system that simply happens to be of high voltage, and with his theory of radio in mind, always looking for the most logical point in the particular installation from which he can expect radiation. We will first check both types of trouble on a window sign. The procedure is as follows: Turn the sign on to see if it is operating properly. If the sign runs fairly steady and without any serious sign of fluttering of the tubing, you can assume that as far as the tubing and transformer go you are O.K. If the sign only lights dimly, or in parts, you can assume a broken unit. The units can be tested with a neon tube tester that can be obtained, complete with directions, from any tube supply house, or by the following method: take a piece of high tension cable and jump across each unit in turn. When the defective unit is jumped the balance of the sign will light. The jumper must of course be connected from the wire of one of the electrodes at one end of the unit to the wire on the other end of the unit. If the entire assembly flutters badly, does not light at all or only in part and we find no defective unit, then it must be the transformer. Disconnect the secondary leads and with a high tension wire for a jumper touch the two secondary terminals. A good hot spark should result. If no spark results, or a weak one, get a new transformer. Most transformers above 7,000 V. are center tapped. In that case they should be tested from the case to each terminal in turn. This will test the two secondary coils, assuming that the sign is operating properly. We will now proceed to clear the radio interference. As we proceed, if any one of these clear the trouble, you, of course, go no further. First, make sure that the sign is running off a different circuit than the radio; second, make sure that the case of the transformer is grounded; third, tie several fine bare wires, (about number twenty-five) across the face of the glass; fourth, cross secondary leads coming from transformer to unit; fifth, break wire suspending sign in window and insert about a 6 in. section of waxed cord or ordinary twine; sixth, cut a 5 A. line filter in the primary circuit of the transformer as near as possible to the transformer. There is one type of installation that is liable to be quite troublesome, that is, where a sign is hung on a leaded glass window. In this case I would first solder fine wires to the leaded sections at four or five points near the sign, tie these wires together and run them to the nearest water pipe for a good ground, then see that the tubing is kept as far as is reasonably possible from the leaded glass.

- With outside signs we proceed about the same as with the window sign. If the sign is on a flasher, filter the motor circuit of the flasher, and if necessary filter each primary circuit across the breaker points in the conventional manner. In general check all installation for these possible points of interference:
- 1—Separate line circuit (at least separate from radio).
 - 2—Transformer and sign cases grounded.
 - 3—Flashers filtered.
 - 4—Keep aerial away from sign.
 - 5—Supply line to sign in metallic conduit and grounded.
 - 6—Fine wire ties across face of units.
 - 7—Loose secondary connections, or arcing to case of sign or other wire.
 - 8—Special reference to window displays.
 - 8—Crossing secondary feeders.
 - 9—Cutting in insulators in suspension wires to stop further radiation from this point.

TRY THIS NEW SPEAKER ASSEMBLY

FIND out for yourself about tremendously increased measure of performance, adaptability and good appearance embodied in this amazing new outfit for every indoor requirement. All-aluminum baffle housing, adjustable wall mounting bracket, improved speaker efficiency with feed-back practically eliminated. Like all Toledo equipment it is dependable first, last and all the time. Write for catalog, prices and data on the laboratory-built TOLEDO line. Learn about our liberal free 5-day trial.



OTHER TOLEDO PRODUCTS

- Portable Sound Systems • Electro-Dynamic Units • Carbon Microphones • Amplifiers • 4, 5 and 6 Ft. All Aluminum Natural-tone Trumpets • Field Exciters • Air Column Horns • Low and High Frequency Units For Wide Range Theatre Use

TOLEDO SOUND EQUIPMENT LABORATORIES
Formerly Bud Speaker Co.
1153 JACKSON STREET • TOLEDO, OHIO, U. S. A.

Train Now for New RADIO Opportunities



Get Into a Line Where There's Action—Every Day—And a Payday Every Week—You Be the Boss!

Analyzer & Resistance Tester—Latest Design—YOURS Without Extra Cost

Right now while hundreds are looking for work where there isn't any, the radio service field can use trained men. With the proper training and the necessary equipment, you can enter this field and make a comfortable living. We include with our course this modern set analyzer and trouble shooter without any extra charge. This piece of equipment has proved to be a valuable help to our members. After a brief period of training you can take the set analyzer out on service calls and really compete with "old timers." We show you how to wire shortwave receivers—analyze and repair all types of radio sets, and many other profitable jobs can be yours. Teaching you this interesting work is our business, and we have provided ourselves with every facility to help you learn quickly yet thoroughly. If you possess average intelligence and the desire to make real progress on your own merits, you will be interested.

ACT NOW - MAIL COUPON

Start this very minute! Send for full details of our plan and free booklet that explains how easily you can now cash in on radio quickly. Don't put it off! Write today. **SEND NOW!**

RADIO TRAINING ASSN. of AMERICA
Dept. RC-510, 4513 Ravenswood Ave., Chicago, Ill.
Gentlemen: Send me details of your Enrollment Plan and information on how to learn to make real money in radio quick.

Name _____
 Address _____
 City _____ State _____



Radio Men!

make the

Hotel PRESIDENT

your headquarters during the SHOW!

★ Only a few blocks from Grand Central Palace

- ★ Every room with Radio
- ★ Every room with Private Bath or Shower
- ★ Famous Hotel President Tap Room

Rates: \$2.50 Single — \$3.50 Double

J. S. Suits, Mgr.

Hotel PRESIDENT

48 St., West of Broadway
NEW YORK CITY

RADIO-CRAFT'S "IDEAL RADIO SERVICE SHOP" CONTEST

(Continued from page 220)

Contest Director:

Tube Checker: No adapters, tests shorts, neon-leakage indicator, actual mutual conductance, plate current and gas-content test, 5 in. meter, minimum tube sockets, spare sockets, minimum controls, actual tube manufacturer's voltages applied to tubes.

Oscillator: A.C. line operated all-wave. R.F. signal generator with 30% modulation by 0-10,000 cycle audio note (A.F. note variable by hand). Pure R.F., and pure R.F. with built-in R.F. modulator to work with oscilloscope. Direct-reading R.F. dial, separate 0-10,000 cycle audio note with direct reading dial, R.F. output calibrated in microvolts.

Output Indicating Devices: (A.C. meter, D.C. milliammeter, neon indicator) all with provisions for each to be connected to a cable at tube socket so that there is no unsoldering of set connections. A.C. oscilloscope, direct-reading dial for linear sweep.

Analyzer: Neon condenser tester, English-reading electrolytic condenser tester, 6 ranges for following: capacity meter for condenser tests, A.C. operated ohmmeter, D.C. milliammeter, D.C. voltmeter, A.C. voltmeter, and decibel meter. Separate rotary range switches for each purpose, two meters.

Socket Selector: Separately attachable to analyzer, 8 prong analyzer plug with 4-5-6-7-8 prong adapters connecting to panel with a separate socket for 4-5-6-7-8 prong tubes, with the usual type of shorting jacks for current and voltage measurements, numbered per R.M.A.

Decade Substitute Condenser Box.

Decade Substitute Resistor Box.

Multi-test Substitute Speaker: Matching all tubes, output transformers and set field coil combinations.

Multi-Test Substitute Power Pack: Connection for all power purposes for all sets.

All Instruments 45° (or less) sloping panels.
HENRY BAL

AN 18 METAL-TUBE ALL-WAVE SUPERHET

(Continued from page 208)

are used. One as a resistance-coupled audio amplifier preceding the 6F6 driver. One is used in the tunalite circuit controlling the dimming action of the pilot light as an indicator

that the set is tuned to a station. One of these is used in the beat-frequency oscillator circuit which is provided as an aid in tuning in the weaker high-frequency stations. One of these 6C5s is used as the main heterodyne oscillator, tuning below five meters.

Two of the 5Z4s are used as full-wave (push-pull) rectifiers. These new metal rectifiers are very quiet in operation.

The last and smallest of these tubes, but not the least in importance is a new development being a duo-diode called the 6H6. This little tube is only about 1 in. high but is by far the best R.F. rectifier that has ever been developed. Two of these are used. One in the A.F. generator circuit (the second-detector) and one is used as a separate A.V.C. bias generator for giving more perfect volume control action.

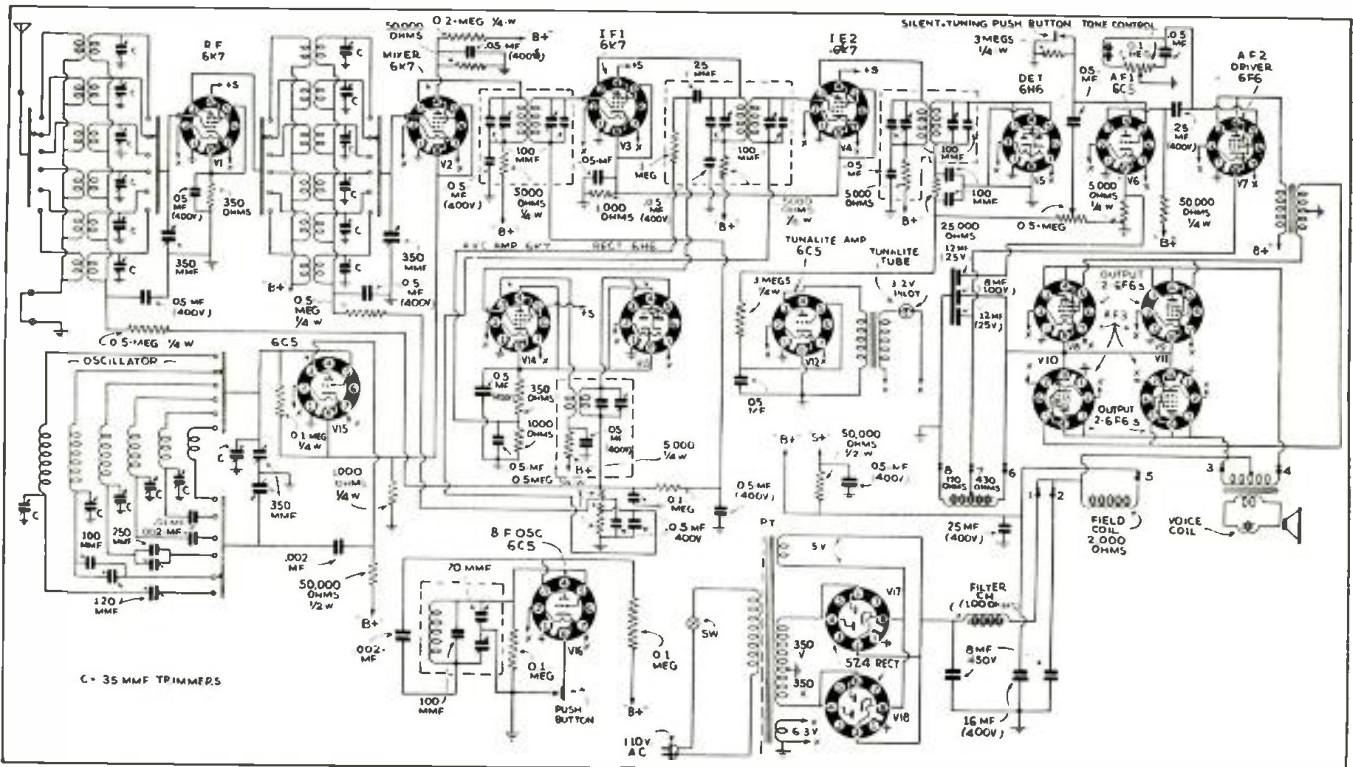

Please Say That You Saw It in RADIO-CRAFT

NOW READY!

The 1935 OFFICIAL AUTO-RADIO SERVICE MANUAL

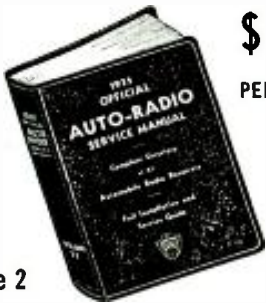

\$2.50

240 Pages

PER COPY

Volume 2

HERE NOW—is the second volume of the OFFICIAL AUTO-RADIO SERVICE MANUAL—the 1935 Edition. With so large a number of new auto-radio sets placed on the market by different manufacturers, the 1935 OFFICIAL AUTO-RADIO SERVICE MANUAL becomes an essential part of Service Men's equipment. Remember, there are nearly 1,800,000 auto-radio sets in use today.

THERE IS ABSOLUTELY NO DUPLICATION OF MATERIAL BETWEEN THE 1933 EDITION (VOLUME I) AND THE NEW 1935 EDITION (VOLUME II). THE MATERIAL IS 100% NEW.

Every radio man connected in any way with the booming auto-radio business needs a copy of the new OFFICIAL AUTO-RADIO SERVICE MANUAL. It contains only auto-radio service "do's."

HERE ARE HIGHLIGHTS OF THE 1935 'AUTO-RADIO MANUAL'

240 pages crowded with diagrams, service material and other essential data required for proper servicing of new auto-radio receivers. Included are diagrams of sets which appeared during 1934, and which were not included in the supplement to the first edition.

Complete schematic diagrams, chassis layouts, voltage tabulations and servicing instructions are included for practically all sets. Under-plate tube symbols are also included to facilitate the job of servicing the sets.

Instructions are included with many sets telling how to suppress cabinet cases of ignition interference. This includes the newest "suppression" sets and what to do when interference is encountered with this type of set.

Details on how to make installation in "turret-top" cars are included. The different methods used by car makers and set manufacturers are listed with the individual circuits and service information.

The index contains the listing of sets which were published in the first edition, as well as the sets which appear in the new volume. This is essential to the Service Man to locate the circuit and details for any receiver that has been made.

The book is bound in a handy, flexible leatherette cover. To be sure the pages are sturdy, a substantial constant use, the book will be printed on a special "hull" stock. This is a very durable, but thin paper. The book printed on this paper can be easily rolled to fit into your pocket or slipped in the service kit.

Here is a Partial List of Sets Covered

- | | |
|--------------------------------|---------------------------------|
| Atwater Kent Mfg. Co. | P. R. Mallory & Co. |
| Audiola Radio Co. | Montgomery Ward & Co. |
| Autocrat Radio Co. | National Company, Inc. |
| Belmont Radio Corp. | Nobilt-Sparks Industries, Inc. |
| Century Radio Products Co. | Philco Radio & Television Corp. |
| Chevrolet Motor Corp. | Pierce Airs, Inc. |
| Chrysler Motor Corp. | RCA Manufacturing Co., Inc. |
| Colonial Radio Corp. | Sears Roebuck & Co. |
| Crosley Radio Corp. | Sentinel Radio Corp. |
| Delee Appliance Corp. | Sparks-Withington Co. |
| Detroit Radio Corp. | Stewart Radio Corp. |
| Emerson Radio & Phonograph Co. | Stewart-Warner Corp. |
| Fada Radio & Electric Corp. | Stromberg-Carlson Tel. Mfg. Co. |
| Ford Motor Corp. | Transformer Corp. of America |
| Ford-Majestic | United American Bosch Corp. |
| Franklin Radio Corp. | United Motors Service, Inc. |
| Galvin Mfg. Corp. | U.S. Radio & Television Corp. |
| General Electric Co. | Wells Gardner & Co. |
| General Motors Corp. | Willcox-Gay Corp. |
| Graham-Paige Motors Corp. | Rudolph Wurlitzer Mfg. Co. |
| Griegsbv-Grunow Co. | Zenith Radio Corp. |
| Chas. Hoodwin Co. | |
| Howard Radio Co. | |
| Hudson Motor Car Corp. | |
| International Radio Corp. | |
| Karadio Corp. | |

Over 240 Pages Printed on Special Thin "Bible Paper" Over 500 Illustrations
Flexible, Looseleaf Leatherette Cover
GERNSBACK PUBLICATIONS, Inc.
99 Hudson Street New York, N. Y.

MAIL COUPON TODAY!

GERNSBACK PUBLICATIONS, Inc., Dept. RC-1035
99 Hudson Street, New York, N. Y.

Enclosed you will find my remittance of \$2.50 for which send me one copy of the 1935 OFFICIAL AUTO-RADIO SERVICE MANUAL, Volume II. Send remittance in check or money order, register letter if it contains cash or currency.

Name _____
Address _____
City _____ State _____
(The 1935 OFFICIAL AUTO-RADIO SERVICE MANUAL is shipped postage prepaid.)

READERS' DEPARTMENT

(Continued from page 226)

About the only thing extra to buy would be the two type 37 tubes, and a 30 watt lamp and socket. Six model "T" Ford coils are required.

These coils should be opened with care and the lead-foil condensers removed. If you want to do a neat job, pack all the condensers in a tin can, taking care to insulate them with pieces of wood, rubber, or glass between. On one side, ground all the ends to the can. The Ford-coil secondary used can also be housed in a can.

The two 5-prong sockets are home-made as previously described in the article.

It is important that the lamp used be not more than 30 W., as a higher rating will either produce excessive hum or burn out the tubes.

Any burned-out audio transformer will do as the choke, as long as the portion of the winding in use is intact. Either primary or secondary winding will work, but the primary is to be preferred.

Although this is a half-wave circuit, it works as quietly as a battery set.

No ground is needed, as the set is grounded to the power line. Care should be taken to see that the former ground wire does not come into contact with the set as it may produce a short-circuit with the power line.

If poor results are had, reverse the plug connection.

JOHN GARCIA,
Tampa, Florida.

"El Junko" as Mr. Garcia calls his set is certainly a novel adaptation of old parts. We believe the circuit would be just as satisfactory without the Ford-coil secondary and the one condenser, as shown in the accompanying diagram. Defective Ford-coils from which good condensers may be obtained, can often be secured at garages for the asking.

GANGED CONDENSERS

Editor, RADIO-CRAFT:

You have been referred to me as a good "settler of problems." I find manufacturers of radio sets divided on the use of gang condensers. Some state that the intermediate plate is unnecessary for insulating purposes. Others state that the intermediate plate is necessary to shield the condenser sections.

I have brought suit against RCA for infringement of my patent for two condensers in one. Patent No. 1,608,472, involving the use of the so-called gang condensers. My patent states that all sets of plates are in the same area of a dielectric medium, which is another way of saying that electrostatic coupling takes place between the sections. I obtained amplification of signals as the main object of such condenser structure. On attached sheet I give you a Weagant hookup in which the gang condenser is used to amplify radio signals. The gang condenser used had no intermediate plate and the sets of plates were in electrostatic relation to each other.

The Armstrong circuit differs from the Weagant circuit in that the regeneration inductances are joined with the filament of the vacuum tube. I have also amplified radio signals in this circuit substituting a gang condenser for inductance coils. It is a more difficult circuit in which to have the different sections of the condenser of opposite signs of polarity. I have improved the method set forth in Patent No. 1,608,472, by another method which I have covered under patent No. 1,949,137, using a crossover panel to effect alternation of polarity.

A third method which would interest the manufacturer of radio sets is to have an alternating current with a phase 180° behind another current of the same frequency, which method produces polarity of opposite sign in gang condensers which can also be used to amplify radio signals by having the same area of a dielectric medium in condensers.

I would like to see this point of controversy settled soon. I am confident that you will find shielding and insulating of condenser sections unnecessary. I used the Weagant circuit because it was the one I experimented with before the advent of the Armstrong circuit.

JOHN J. AURYNGER,
Box No. 4253,
Takoma Park, D.C.

Only the NEW SCOTT gives you
ALL THE WORLD
and
ALL THE TONES

●NOW! SCOTT has achieved what radio engineers have been striving for from the very beginning—**COMPLETE TONAL**

RANGE—every high and low tone, every trembling bass of the organ, every thrilling, singing overtone of voice and violin. Only with a SCOTT can you get ALL THE TONES from the new HI-FIDELITY programs.

This astounding SCOTT achievement is unchallenged throughout the radio world—just as SCOTT DX records have remained unchallenged through the years.

Add to this, High Useable Sensitivity, add Continuously Variable Selectivity, add Distortionless Peak Reception, add Automatic Perfected Volume Control—and all the other SCOTT proven superiorities for tone and distance reception—and you have the receiver justly acclaimed the world over as first choice, with both DX and broadcast band enthusiasts. It stands alone, bringing you programs from stations in every part of the world—with clear full tone.

Custom-built—sent direct from the laboratories on a 30-day trial (in U.S.A. only). Send today for the most interesting story of unmatched radio reception from every quarter of the globe.

YOU MISS A LOT IF YOU HAVEN'T A SCOTT

SCOTT
Full Range Hi-Fidelity
RADIO



E. H. SCOTT RADIO LABORATORIES, INC.
4404 Ravenswood Ave., Dept. 24R5, Chicago, Ill.

Send details about the new SCOTT receiver, PROOF of its superior tone and DX performance.

Name _____
Address _____
City _____ State _____



UTAH 8"

MAGNETIC SPEAKERS
Limited Quantities

Shipping Weight—3 lbs. This highly efficient speaker is an outstanding value. It has an extra heavy magnet and is ideal for use as an extra extension speaker or in battery sets. Mounted on a rigid steel frame with mounting holes.

\$1.55 each

Write for our special circular radio parts and tubes.

UTAH 6" AUTO DYNAMIC SPEAKERS

FULLY GUARANTEED

First quality of latest design. Excellent full rich tone. Rigid construction.

\$1.55 each

7-TUBE SUPER KIT

Kit includes: ANTENNA COIL; R.F. COIL; OSCILLATOR COIL; 1st I.F. COIL; 2nd I.F. COIL; INPUT TRANSFORMER; OUTPUT TRANSFORMER; 3-GANG TUNING CONDENSER. Price—**\$2.25**

Schematic circuit diagram for A.C. and Auto Receiver furnished.



T.R.F. KIT

ANTENNA COIL; 2 R.F. COILS; 3-GANG TUNING CONDENSER. Price—**\$1.25**

Send enough money for parcel post or we ship by express collect.

ARROW SALES CORPORATION
549 West Randolph St. Chicago, Illinois

Please Say That You Saw It in RADIO-CRAFT

YOU WON'T BELIEVE YOUR EARS... when you LISTEN TO THE NEW WRIGHT-DeCOSTER

Model 1750 12" Reproducer featuring the revolutionary WRIGHT-DECOSTER PARA-CURVE DIAPHRAGM

- Eliminates Sub-harmonics
Greatly assists in elimination of high frequency cancellation in large diaphragms
Extends the range of the reproducer into the higher frequencies further than was ever possible with the ordinary type cones

List price \$17.50

Write for complete catalog, dealer's discount and name of nearest distributor. Wright-DeCoster distributors are always anxious to cooperate with you.

WRIGHT-DECOSTER, Inc. 2251 University Ave., St. Paul, Minn.

Export Dept. M. Simons & Son Co., Cable Address, SIMONTRICE, N.Y.

THE LISTENING POST

(Continued from page 223)

be comparable for a short period of time to ordinary domestic DX. I have known these far away stations on rare occasions to be so loud for a moment as to burst in with local volume!

Moving on down the dial you will find your most likely catches located at the following points: 610 kc.—2FC., Sydney, Aust.; 630kc.—3AR, Melbourne, Aust.; 670kc.—2CO, Corowa, Aust.; 690kc.—6WF, Perth, Aust.; 730kc.—5CL, Adelaide; 740kc.—2BL, Sydney, Aust.; 770kc.—3LO, Melbourne; 800kc.—4QG, Brisbane, Aust.; 870kc.—2GB, Sydney, Aust.; 950kc.—2UE, Sydney, Aust.; 1,030kc.—3DB, Melbourne, Aust.; 1,110kc.—2UW, Sydney, Aust.; 1,120kc.—4BC, Brisbane, Aust. The leading New Zealand stations may be found on 570kc.—2YA, Wellington, N.Z.; 650kc.—1YA, Auckland, N.Z.; 720kc.—3YA, Christchurch, N.Z.; 790kc.—4YA, Christchurch, N.Z. Be on the lookout for the new Australian Regional Stations on 550kc.—2CR; 560kc.—6WA; 580kc.—3WV; 600kc.—4QN; 700kc.—2NR; 720kc.—6GF; 750kc.—7NT; and 830kc.—3GI.

LONG-WAVE STATION REPORT

The Chief Engineer of the technical service of Radio Luxembourg, Luxembourg, Luxembourg, writes, making a special request that all our readers make an effort to tune in their station and send them reports. Luxembourg is one of the world's most powerful stations with an aerial power of 200kw., and transmits on a wavelength of 1,304 meters, or 230 kc. Luxembourg transmits daily from 2:45 to 3:30 a.m. E.S.T., from 7:00 a.m. to 9:00 a.m., and from 1:15 p.m. to 6:00 p.m. E.S.T., and on Saturdays from 10:45 a.m. to 7:00 p.m. E.S.T. (It is suggested that listeners try for Radio Luxembourg from 2:45 to 3:30 a.m. E.S.T., from 5:00 to 6:00 p.m., or from 5:00 p.m. to 7:00 p.m. on Saturday nights, as these would be the most logical times for tuning in this long-wave giant. It is to be remembered that only a few sets are equipped with a long-wave band.—Ed.)

BROADCAST BAND NEWS.

From Mr. A. Saito, of Kumamoto, Japan, comes this exclusive information on new stations, and changes in the broadcast line-up in the land of Nippon. (1) JFCK, Taichu, Taiwan island, is now officially on the air, operating on 580kc., with 1kw. JFCK is owned by the Broadcasting Corp. of Taiwan. (2) JBAK, Fuzan, Chosen, will be opened before September of 1935 with an antenna power of several hundred watts, and will operate on approximately 1,020kc. JBAK is owned by the Broadcasting Corp. of Chosen. (3) The following stations will be opened before the next DX season with an antenna power of 500 W. each. Kagashima on 760kc., and Toyama on 1,060kc. Call letters have not been assigned as yet. They will be operated by the Broadcasting Corp. of Japan.

In addition to the several powerful new regional stations which will soon be in operation in Australia several changes, and new stations have occurred which are as follows: (a) a new station 4GY is being constructed at Oakley, near Toowoomba, Queensland, by the owners of 4BK, Brisbane to serve as a relay station for 4BK. The station will have an aerial power of 1,000 W., and will begin operation on 1,220kc. about September 1st. The new station 4IP at Ipswich, Queensland, will also be in full operation by Sept. 1, on 1,440kc. (b) a new station, 4CA, situated at Cairns, North Queensland, is now operating on 1,470kc. (c) a station, 3XY, will be erected at Melbourne, Australia by Pty., Ltd., owners of "Efttee Attractions."

ROAMING THE HIGH FREQUENCIES

On June 1st, J.V.H. Nazaki, Japan, was scheduled to have started an "Over-Seas Broadcast Hour" especially for American listeners at 8:30 to 9:30 p.m., E.S.T. Apparently this hour did not materialize, but about one month later on June 21st, the "Over-Seas" hour appeared at 12 midnight to 1:00 a.m. E.S.T. This daily feature from Japan over J.V.H. 14.6mc. has been reported with good signal strength by several of our readers. In signing off reports are requested to be addressed to the "Agency



FREE

IMPORTANT ILLUSTRATED BUYING GUIDE FOR RADIO EXPERIMENTERS. SERVICE MEN AND SHORT-WAVE FANS.—32 Pages—Two Colors—Profusely Illustrated This Book Will Save You Money! Packed between the covers of this 32-page book is a tremendous array of modern radio equipment and other electrical and scientific merchandise—the very material for which you have been looking—and at prices which cannot possibly be any lower.

RADIO TRADING CO. 97 Hudson St., New York, N.Y.

A. C. ELECTRICAL POWER

from a Windmill, from available Waterpower, from your Automobile, from your Motorcycle, from your Bicycle, Foot-pedal or Handcrank (for transportable Radio Transmitters, Strong Floodlights, Advertising Signs); do you want to operate AC Radio sets from 32 V. DC farm light systems; operate two generators in series to get 200 V. AC; obtain two phase and three phase AC, etc., etc.

Get Our Westinghouse 200 Watt, 110 V. AC Power Generator Manufactured for U. S. Signal Corps

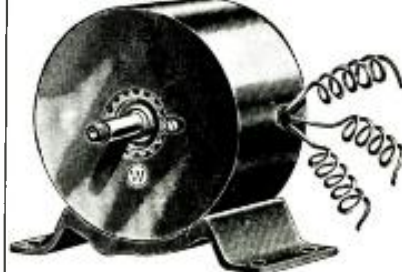

SPECIFICATIONS HOUSING—Aluminum (Diameter 6 1/2 in., Length—5 1/2 in., SHAFT—2 3/16 in. driving end, Diameter 9/16 in. (other end threaded for a distance of 3/4 in.). BASE—Cast Iron (Length—7 1/2 in., Height 1 9/16 in., Width 4 1/2 in., C.U.P.T.P.—200 Watt, 110 Volt, AC (operating 4500 R.P.M., 60 cycles per sec.) plug (two North and two South). ROTOR—12 tooth induction. Built-in commutator. Rotor turns in ball bearings. 1/4 to 3/8 H.P. needed to run generator.

FREE With each generator, we supply a set of diagram-blue prints and instructions showing twenty-five different uses, technical information, electrical hook-ups and installing explanations. We also include a set of four replacement carbon brushes.

There Are Over 25 Applications Some of which are:

A.C. Dynamo Lighting from eight to ten 20 Watt 110 Volt lamps. Short Wave Transmitter supplying 110 Volts AC for operating "Ham" transmitter. Operating 110 V. AC 60 Cycle Radio Receiver in DC districts. Motor Generator, Public Address Systems, Electric Sirens on motor boats, yachts, etc. Camp Lighting, Short Wave artificial "Teevee" apparatus, Television, Pelton Waterwheel for lighting or other purposes, Airplane for lighting strong search lights or electric signs, Laboratory work, etc. Generator, as described, including four replacement carbon brushes. Blue-print and instructions \$7.90

Send \$2.00 deposit balance C.O.D. Shipping weight 18 lbs. (Replacement carbon brushes bought separate \$1.50 per set of four. Set of instructions bought separate \$1.00.) MONEY-BACK GUARANTEE DO NOT WRITE FOR CATALOG

WELLWORTH TRADING COMPANY SW-10-35 560 W. Washington Blvd., Chicago, Ill.

Enclosed you will find my remittance of ... for which please send me [] Westinghouse Power Generator by Express collect or balance C.O.D.

Name ... Address ... City ... State ...

STEP AHEAD IN THE SERVICE PROFESSION WITH CASE RECORDS OF BROADCAST RECEIVER REPAIRS

ADD 10,000 HOURS to your experience! ELIMINATE GUESS-WORK in your Servicing. DON'T PUZZLE YOUR PROFITS AWAY! Your work is already done and recorded for you in "CASE RECORDS." This 9x12" leatherette binder CONTAINS 1,500 alphabetically and numerically arranged case records of SUCCESSFULLY COMPLETED SERVICE JOBS. Each record tells—symptom—parts responsible—electrical values—location—and best replacement or repair. Fastest Servicing technique known. 108 Receiver Models—3,000 Models. SUPPLEMENTED QUARTERLY FREE for 1 year. CAPITOL RADIO RESEARCH LABORATORIES INC. 923 National Press Bldg. Washington, D. C.

Kindly forward full details on "CASE RECORDS." NAME ... ADDRESS ...

Become a Radio Expert GOOD JOBS Learn RADIO-TELEVISION

Electricity—Talking Pictures—in Los Angeles Learn profitable trades by practical shop methods. Enroll with National, subject, largest trade school in the West. 30,000 graduates. Quality as a radio repair man, television expert, sound expert, broadcast station technician, electrician and for many other jobs. Earn room and board while learning. Here's opportunity for you. For limited time we will allow each railroad fare to Los Angeles. Send for free book which gives full details about different jobs you can do for free complete course of instruction and photographs of school operations. Sign and mail coupon.

NATIONAL SCHOOLS, Dept. 10-RC, 4000 So. Figueroa St., Los Angeles, Calif. Please send me your Free Book on Radio and Television, Talking Pictures Radio and Electricity. Also details of R. R. fare offer. Name ... Address ... City ... State ...

Turn to page 251 of this issue and read complete details about the new, 1935 OFFICIAL AUTO-RADIO SERVICE MANUAL which has recently been published.

Please Say That You Saw It in RADIO-CRAFT

Which OF THESE Gernsback Service Manuals do you need to complete your files?

Perhaps you are missing some important radio data from your files—some information which you might need to service or repair older model radios. There's just one place to find this "dope"—that's in the GERNSBACK OFFICIAL RADIO SERVICE MANUALS. Order the copy you need—mail the coupon below for convenience.

1934 OFFICIAL RADIO SERVICE MANUAL

Over 400 Pages, 9x12 Inches.
Over 2,000 Illustrations
Flexible, Looseleaf, Leatherette Cover.

List Price **\$3.50**

1933 OFFICIAL RADIO SERVICE MANUAL

Over 700 Pages, 9x12 Inches.
Over 2,000 Illustrations
Flexible, Looseleaf, Leatherette Cover.

List Price **\$5.00**

1932 OFFICIAL RADIO SERVICE MANUAL

Over 1,000 Pages, 9x12 Inches.
Over 2,000 Illustrations
Flexible, Looseleaf, Leatherette Cover.

List Price **\$5.00**

1931 OFFICIAL RADIO SERVICE MANUAL

650 Pages (Including Supplements),
9x12 Inches.
Over 1,500 Illustrations
Flexible, Looseleaf, Leatherette Cover.

List Price **\$4.50**
(Including Supplements)

1933 OFFICIAL AUTO-RADIO SERVICE MANUAL

Over 200 Pages, 9x12 Inches.
Over 500 Illustrations
Flexible, Looseleaf, Leatherette Cover.

List Price **\$2.50**

To order—simply fill in coupon below and mail with your remittance in the form of check or money order. Register letter if it contains cash or unused U. S. stamps.

GERNSBACK PUBLICATIONS, Inc. 99 Hudson Street New York, N. Y.

GERNSBACK PUBLICATIONS, Inc. RC-1035
99 Hudson Street, New York, N. Y.

Enclosure: Enclosed you will find my remittance of \$_____ for which send me, POSTAGE PREPAID, the GERNSBACK OFFICIAL RADIO SERVICE MANUAL which I have indicated below:

<input type="checkbox"/> 1934 Manual	\$3.50
<input type="checkbox"/> 1933 Manual	\$5.00
<input type="checkbox"/> 1932 Manual	\$5.00
<input type="checkbox"/> 1931 Manual	\$4.50
(Including Supplements)	
<input type="checkbox"/> 1933 Auto-Radio Manual	\$2.50

Name.....
Address.....
City..... State.....
(Be sure to check off the Manual which you need)

for Broadcasting for Japan." Tokyo. The programs include news in English, news in Japanese, etc., as well as Japanese music.

KYW will have a short-wave relay station with call W3XK, and it is rumored that KOHL, Council Bluffs, Iowa, will build a short-wave relay.

VE9CS, Vancouver, B.S., on 6.07mcs. and using a stated power of 2½ w. has been putting on a DX program on Monday mornings at 1:00 a.m. E.S.T.

FNSK, the S.S. Normandie is operating its ship transmitter on four separate channels: 17mcs. during the mornings, 12.8mcs. during the afternoons, 8.5mcs. for the evenings, and 4.2mcs. when nearing port.

XEBT, Mexico, D.F., 50 meters, puts on a 500 word sports summary each night at midnight E.S.T.

TI-1NRH, the famous station of Amando Cespedes Marin, Heredia, Costa Rica, is no more, but in its place the son of Amando is operating an amateur station TI-1AC on 7.21mcs, which threatens to become as popular as the TI-1NRH X'm't'r. was previously.

OER2, Vienna, on 6.07mcs. has been experimenting irregularly with special transmissions at 7:00 to 10:00 p.m. E.S.T. If the reports on these broadcasts are favorable a regular service at this hour may be instituted directed mainly at South America.

W10XFP, the "Schooner Morrisey," was heard testing off Staten Island, near the low-frequency side of the 20 meter ham band.

The only new station of any importance that has appeared during the last thirty days is HJ5ABE, of Cali, Colombia. HJ5ABE is located on 14.1mcs., and is reported to have about 750 W. of power. The station announces as "Radio-difusora Colombiana," and preceding the call sounds three chimes somewhat similar to the NBC chimes. This station was first heard by the writer on the night of June 3rd. Since that time it has been reported with excellent signal strength in all parts of the country.

Transmission No. 6, of the British Broadcasting Corp. proved so popular on its four times a week schedule that it was decided to make a daily feature of it. Transmission No. 6, which is transmitted primarily for Western Canada is radiated daily at 10:00-11:00 p.m. E.S.T., over GSD, 11.75mcs., and GSC, 9.58mcs.

The B.B.C. is enlarging its short-wave facilities at Daventry with the addition of two entirely new transmitters of higher power than those at present in use. When the two new X'm't'rs are completed the two older ones will be combined to form a single unit of increased power, making in all three super-power short-wave transmitters available for simultaneous radiation.

RNE, 12mcs., Moscow, U.S.S.R., is now being heard with an afternoon schedule from 1:00 to 5:00 p.m. E.S.T. Various parts of the afternoon schedule are transmitted in Russian, German, French, English, and sometimes Spanish. This afternoon schedule is in addition to the usual Sunday schedules of 6:00-7:00 a.m., 10:00-11:00 a.m. E.S.T.; Wednesday 6:00-7:00 a.m.; and Saturday from 10:00 to 11:00 p.m. E.S.T.

YV2RC, Caracas, Venezuela is expecting their new 1,000 W. transmitter any day, and believe that when it is installed they will be one of the best heard South American stations in the United States according to their director Mr. Edgar Anzola.

COMMERCIAL STATIONS—GERMANY

Part II.

Doberitz, DOA, 3,620, 4,430, 7,230, 7,930.
Konigswusterhausen, 3,660, 3,760, 7,610, 8,068.
Nauen, DFA, 19,240; DIQ, 10,290; DFB, 17,512; DJK, 12,035; DEB, 17,520; DWG, 20,110; DFD, 14,665; DFH, 7,333; DFQ, 18,700; DFT, 7,813; DGE, 22,520; DGF, 22,600; DGG, 13,180; DFJ, 19,700; DFL, 10,850; DFM, 19,460; DGH, 10,440; DGK, 6,680; DGM, 21,340; DGN, 21,180; DGP, 20,740; DGQ, 20,500; DGU, 9,620; DGW, 20,140; DHC, 11,435; DHO, 20,020; DIH, 19,947; DIM, 17,341.
Norddeich, DAF, 4,130, 4,400; DAF, 8,470, 12,325; DAF, 12,394, 12,745; DAF, 17,260.
Norden, DAN, 11,340, 16,665.
Rugen, DAS, 4,050, 5,635; DAS, 8,540.
Airways, 6,250.
Naval Stations, 4,500, 8,765, 11,140, 13,100; 16,130.



**POINTS THE WAY.
TO GREATER PROFITS**

New! Bigger! Better!

FREE!

You owe it to yourself to write for a copy of this new Profit Guide.

The Most Complete RADIO PARTS CATALOG Ever Published

The New Radolek 1935 Fall Edition of the Profit Guide is the most complete Radio Parts Catalog ever published—new, bigger and better. Everything in radio—at the right prices. Over 160 pages of valuable, money-saving "radio-buying" information. Over 8000 separate Repair Parts—hundreds of new items—a complete, new selection of Radio Receivers and Amplifiers. Contains the most complete, exact duplicate, replacement parts listings, of volume controls, condensers, transformers, vibrators ever compiled. Nowhere, ever, has there been a Radio Parts Catalog comparable to this superb book. Every page brings you extra profits. This is your book—it's FREE. If you want the best Radio Parts Catalog—if you want to give better service at bigger profits—then send for this NEW Radolek Profit Guide.

RADOLEK restricts distribution of this catalog to active and legitimate Radio Men. Please enclose your business card or letter-head—

THE RADOLEK CO.
630 W. Randolph St., Chicago

Send me FREE the Big New RADOLEK PROFIT GUIDE.

Name.....

Address.....

Are You a Serviceman? Dealer?

Years Experience?

BURIED TREASURE Locating INSTRUMENTS

THE ONLY DEVICE OF ITS KIND SOLD WITH A BONDED NOTARY PUBLIC MONEY BACK GUARANTEE.

SEND 10c FOR BULLETIN

RADIO METAL LOCATING COMPANY—Dept. M
P. O. Box No. 5693, Cleveland, Ohio

COUPON

MAIL THIS TODAY

Free for the Asking!

"Multi-Tap" Guide, listing 2114 models of radios

which you can immediately service with one of only five (5) "Multi-Tap" Power Transformers.

Auto-Radio Vibrator Guide listing 220 models of radios on which you can replace the vibrator with one of 22 General Units.

Amateur Progressive Transmitter power unit Bulletin.

Check the items you are interested in

General Transformer Corporation
504 S. Throop Street Chicago, Ill.

Please Say That You Saw It in RADIO-CRAFT



The OUTSTANDING ALL-WAVE SIGNAL GENERATOR

THE highest requirements of precision and convenience for all-around work are met in the Model 339 Signal Generator, that works on a.c. or d.c. of 90-125 volts, to measure frequencies from 54 to 17,000 kc and line up channels. It also serves for determining the frequency of a station that is being received.

Coincidence of generated frequency and scale reading is 1 per cent. This high order of accuracy obtains in no other instrument selling at less than twice the cost of the 339.

Many, no doubt, have been somewhat confused by the numerous type of signal generators, but will note that the best of them cover wide ranges on fundamentals, have an attenuator, and permit of pressure or absence of modulation. Also they have a vernier dial and are direct-reading in frequencies, accurate to at least 3 per cent. The 339 has all those advantages, besides affording wavelength determinations as well, and operation on 90-125 volts a.c. (any commercial frequency) or d.c. And the accuracy is three times as great. Moreover, the 339 is well built, for lifetime use, and covers all waves fundamentally, besides permitting measurements of frequencies up to 100 mc (down to 3 meters) by resort to a slight calculation method, applying a simplified harmonic system to the 5,400 to 17,000 kc fundamental band.

The 339 has a 6D4 rf. oscillator, a 37 rectifier tube, so that d.c. is used on the plate, while modulation is provided by a neon tube relaxation oscillator at a frequency of about 1,000 cycles.

- MODEL 339. A 5-band Signal Generator, 54 to 17,000 kc., all on fundamentals, switch operated, direct reading in frequency and wavelength; universal operation. Modulation on-off switch and attenuation. Electro-coupled. Wired, tested, calibrated, with three tubes (6D4, 37 and neon). Shipping weight, 8 lbs.

\$16.00



RADIO CONSTRUCTORS LABORATORIES
 136 LIBERTY STREET Dept. RC NEW YORK, N. Y.
 All Shipments in 24 Hours After Receipt of Order.

INTERNATIONAL RADIO REVIEW

(Continued from page 221)

The Austrian magazine *Radio Welt* recently contained a circuit which will permit this condition to be obtained, by a careful choice of values. As seen from the circuit, Fig. 2, a resistor, R1, is ganged to the shaft of the tuning condenser, so that when the set is tuned, the grid will return to a different point on the resistor for every position on the tuning scale. As the dial is turned toward the high-frequency end of the scale where oscillation takes place more readily than at the low-frequency end (except for very high frequencies where tube capacity reduces oscillation as the frequency is increased) the resistor R1 is automatically adjusted to reduce the regeneration. The resistance curve of resistor R1 must be especially suited to the particular conditions encountered, to produce absolutely constant regeneration, but even with a "straight" characteristic, its use will improve the results.

NEW ENGLISH PHONO. RECORDER

IN AN interesting article on the subject of transcription programs in England, which appeared recently in *Wireless World*, a new type of recorder was shown.

This recorder, illustrated in Fig. D, contains a synchronous motor which drives the turntable at a speed of either 78 or 33 1/3 r.p.m. also drives the cutting head across the face of the record, so that uncut records can be used; the groove being made by the cutting head.

A series of mechanical filters in the motor drive make the motion absolutely uniform and free from "jerks" or other irregularities which might be evident in the reproduction.

The high quality of workmanship on this device is clearly seen from the photo. This unit is especially made for the cellulose-coated aluminum records which are also finding much favor in the U.S.

OPERATING NOTES

(Continued from page 224)

loaded by the breakdown of the 16,000 ohm resistor shown in Fig. 3C, the resistance of which falls to a very low value. The 8,000 ohm unit should be replaced and a 10 watt resistor of the nearest standard value, usually 15,000 ohms, put in, in place of the defective 16,000 ohm unit.

ROGERS R-561

THE owner of this radio complained of distortion when tuned to a strong local station and the volume control turned down. All other stations came in clearly. This set, see Fig. 3D, uses a 57 as autodyne oscillator, a 58 as I.F. amplifier, a 57 as second-detector, a 47 as power amplifier, and a type 80. The volume control and all parts of the volume control circuit checked OK. The volume control acts as a combined antenna and "C" bias control, controlling the bias on the 58. Resistor R was removed from the circuit. This cleared up the distortion, but gave insufficient control. It now became evident that the antenna input was not being reduced at as great a rate as the bias on the 58 was being increased; when the 58 was biased almost to cut-off, the 57 autodyne was still receiving enough voltage from the antenna to overload it (only on a very strong station, of course). Several different resistors were tried in place of the 50,000 ohm one that had been removed from the circuit until a size was found that, with the volume control full off, and tuned to the loudest local station, cut the volume down just enough to keep it from being heard. The size in this case was .15-meg. This gave perfect, smooth control of volume and no distortion. The customer was very well pleased, as several other service organizations had failed to correct the trouble.

While I have only as yet come across one case of this trouble, it is liable to occur in any receiver of this model which may be operated near a powerful transmitter.—W. WELSH.

RADIO-CRAFT'S INFORMATION BUREAU

(Continued from page 227)

turning to chassis (ground) as indicated in dotted lines.



--for the real servicing "dope" you can't find a better book!

NO other radio book is comparable to the new 1935 OFFICIAL RADIO SERVICE MANUAL. In contents, in style of printing, in grade of paper, in illustrations, there has never been published such a comprehensive volume. The 1935 Manual contains over a thousand pages—yet it is only 1 1/4 inches thick because it is printed on a special Bible stock which is an exceptionally good stock, yet one of the thinnest and most durable papers. This 1935 Manual is the most authentic and elaborate service guide ever used in the radio industry. Service Men and dealers who use this 1935 Manual are astonished by finding in it such a wealth of profitable service information which has never been published before.

Contents of the 1935 Manual

Over 1,000 pages full of diagrams and essential information of manufactured receivers—only data of real use in servicing is included. This new Manual is really portable since it will be extremely thin and light as well. ● Volume V continues where the preceding manual left off. ● Many circuits of old sets are included. ● Service Men know every set has certain weak points which are really the cause of trouble. Wherever the information could be obtained, these weaknesses with their cures are printed right with the circuits. This is an entirely new and valuable addition to the Manual. ● All the latest receivers are included—all-wave sets, short-wave sets, auto-radio sets, midget and cigar-box sets, etc., as well as P.A. amplifiers and equipment, and commercial servicing instruments. ● The cumulative index is even more complete than before; including cross-reference to sets sold under different names and type numbers. ● Volume V includes resistance data; socket layouts; I.F. data; and voltage data. ● Tube data on latest tubes. ● Free question and answer service—as included in our last three manuals.

OVER 1,000 PAGES

Over 3,000 Illustrations. Flexible, loose-leaf leatherette covers. Size 9x12"—yet only 1 1/4" thick

GERNSBACK PUBLICATIONS, Inc.
 99 Hudson Street New York, N. Y.
MAIL COUPON TODAY!

What Others Say about this Manual:

Norfolk, Va.
 I received the OFFICIAL RADIO SERVICE MANUALS ordered as per my letter of March 20, 1935 in good order.

I am very well pleased with same as it is a very valuable Radio Service data reference and guide. Arthur J. Freeman.

Detroit, Mich.
 Received your 1935 OFFICIAL RADIO SERVICE MANUAL and certainly is something to rave about. It's great. A. Hecker.

Stillwater, Maine.
 I have received the 1935 Manual, and I am very much pleased with my investment. Franklin J. Holmes.

Swift Current, Saskatchewan, Canada.
 I beg to acknowledge receipt of my 1935 issue of the OFFICIAL RADIO SERVICE MANUAL. Your Manual is fine, and would not be without any of them. The Manual may be improved for Canadian use. A. M. Ford.

GERNSBACK PUBLICATIONS Inc., 99 Hudson St., New York, N.Y.

Enclosed find my remittance of \$7.00 for which send me. POSTAGE PREPAID. One Copy of the 1935 OFFICIAL RADIO SERVICE MANUAL. [Send remittance by check or money order; or register letter if it contains cash, currency or unused U.S. Postage stamps.]

NAME

ADDRESS

CITY STATE RC-10-35

Please Say That You Saw It in RADIO-CRAFT

● Index to Advertisers ●

A	
Aerovox Corporation.....	233
Allied Radio Corp.....	237
Alloy Transformer Co.....	243
Amperite Corporation.....	243, 246
Arco Tube Company.....	248
Arrow Sales Corp.....	251
Autopower, Inc.....	241
B	
Blan the Radio Man, Inc.....	243
C	
Capitol Radio Research Labs.....	252
Central Radio Laboratories.....	238
Coast-to-Coast Radio Corp.....	246
Consolidated Radio Products Company	245
Continental Carbon, Inc.....	244
Cornell-Dubilier Corp.....	236
Coyne Electrical School.....	193
E	
Eilen Radio Laboratories.....	245
Electrad, Inc.....	231
Electric Soldering Iron Company, Inc.	238
G	
General Cement Mfg. Co.....	240, 243
General Electric Company.....	Back Cover
General Transformer Corp.....	253
Globe Apparatus Company.....	245
Goldentone Radio Company.....	247
H	
Hammarlund Mfg. Company.....	255
Hygrade-Sylvania Corp.....	232
I	
Insuline Corp. of America.....	234
International Correspondence Schools	255
International Resistance Co.....	247
J	
J. M. P. Mfg. Co.....	240
K	
Kato Engineering Company.....	245
The Ken-Rad Corporation.....	241
L	
Arthur H. Lynch, Inc.....	241
M	
McGraw-Hill Book Company.....	240
M. & H. Sporting Goods Co.....	245
Midwest Radio Corp.....	Inside Back Cover
Million Radio & Television Co.....	236
The Muter Company.....	233
N	
National Electrical & Radio Exposition	196
National Radio Institute.....	195
National Schools, Inc.....	252
National Union Radio Corp.....	244
O	
Oxford Radio Company.....	241
P	
Plan Shop.....	247
Precision Resistor Company.....	234
Hotel President.....	250
R	
R-S Merchandising Committee.....	246
Racon Electric Company.....	233
Radio & Technical Pub. Co.....	248
Radio Circular Company.....	231
Radio City Products Company.....	245
Radio Construction Laboratories.....	254
Radio Laboratory Instrument Co.....	245
Radio Metal Locating Co.....	253
Radio Training Association.....	249
Radolek Company.....	253
Rythoon Production Corp.....	238
RCA Institutes, Inc.....	242, 243
Readrite Meter Works.....	235
Remington Rand, Inc.....	248
S	
S. O. S. Corporation.....	245
E. H. Scott Radio Laboratories.....	251
Servicemen's Pub. Company.....	245
Solar Mfg. Company.....	244
F. L. Sprayberry School.....	242, 245
Standard Transformer Corp.....	248
Supreme Instruments Corp.....	Inside front cover
T	
Thor Radio Company.....	231
Toledo Sound Equipment Labs.....	249
Triplet Elec. Instrument Co.....	243
Triumph Mfg. Co., Inc.....	247
Try-Mo Radio Co., Inc.....	243
V	
D. L. Van Leuven.....	241
W	
Weston Electrical Instrument Corp.....	239
Wholesale Radio Service Co.....	256
Wright-DeCoster, Inc.....	252

(While every precaution is taken to insure accuracy, we cannot guarantee against the possibility of an occasional change or omission in the preparation of this index.)

ORSMa MEMBERS' FORUM

(Continued from page 225)

ready to call, I have the information I want. Of course, a record is made of the answers to these questions, and in a day or so, I follow it up with a letter. For instance, at one home I visited I got the following information: Name; address; Majestic 72; bought four years ago; not giving satisfactory service; tubes never changed. This is the kind of letter I sent the next day:

Mr. So-and-So:

A few days ago you were visited by one of our radio experts. You said at that time that your radio was not giving you satisfactory reception. You were told by the expert that your tubes are perhaps weak. Four years is a long time for a set of tubes in any receiver.

We are giving a 10 per cent discount this week to all those who buy a complete set of tubes; these are delivered to your home, placed in your receiver, and the set given a free inspection service. Take advantage of this opportunity now, and be able to enjoy your radio at its best.

The deal was closed the next day, and I also installed a lightning arrester. (Of course these letters are typewritten; my sister is a stenographer and takes care of the typing, etc.)

I am also sending you some sketches of how I keep my magazine file. This method has saved me a lot of trouble and time. Hoping this will be of help to some brother Service Man, I remain,

A. B. CORIDEO,
Waterbury, Conn.

These methods may well be followed by others. We have reproduced the center pages of one of Mr. Corideo's pamphlets. On the front page in half-inch letters are the words, "\$25.00 REWARD," while the back enumerates the various tests that were made for the service charge of \$1.50 (now, \$1.00), and the address of the "Certified Service Laboratory." The wording is as follows: (1) Test your radio set; (2) Test loudspeaker; (3) power pack; (4) test all tubes; (5) measures house current—and any other tests that may be necessary; minor repairs will be made without extra charge.)

I will pay \$25.00 reward to any one whose radio set I cannot repair.

This reward is posted as a guarantee that your set will be repaired properly.

No matter what radio receiving set you own, electrically or battery operated, no matter if it be old or new regardless of what condition it be in, call phone or write:

CORIDEO'S
CERTIFIED RADIO SERVICE
LABORATORY
Authorized Silver-Marshall
Service Station

Member and Rated By
THE RADIO SERVICE MANAGERS
ASSOCIATION

Mr. Radio Owner
A 50-cent coupon mailed weekly (except on Sundays) will be mailed to you in the envelope. It will be mailed to you in the envelope. It will be mailed to you in the envelope. It will be mailed to you in the envelope.

Is your radio working satisfactorily, or is it just working?

Perhaps you have been using your radio for the past six months or so without having it checked. It may be that just a tube, or some minor accessory is standing between you and complete radio enjoyment.

If you suspect anything wrong with your radio set, you should call an expert Radio man and let him repair the defect.

I am technically trained and equipped with the most modern Laboratory and testing instruments to service and repair all makes of Radios, power packs and eliminators at a reasonable price.

PHONE
9457W

One side of Mr. Corideo's folder.

P.A. QUESTIONS AND ANSWERS

(Continued from page 227)

standard 200-ohm output. Individual volume control of each speaker is thus possible without affecting the setting of the other controls.

SERVICE HINTS

SERVICE HINTS (Vol. 2). Published by Hygrade Sylvania Corp., Emporium, Pa. Size 4 1/2 x 6 ins. Paper bound, 72 pages. Free for the asking. The first 19 pages of this valuable book are devoted to tables, formulas, and all manner of useful information. Then follows the service hints in alphabetical order. Most all of the material came from actual service experiences in the field. The material is all new, none of it appearing in Vol. 1, and the Service Man will find it of great value.

WHAT YOU NEED TO SUCCEED IN RADIO



Courtesy of the National Broadcasting Company

RADIO is a highly specialized business. As it develops it is becoming more exacting in its demands. But radio is the modern field of opportunity for those who keep step with its progress!

There is a great need for trained men in the radio industry. There is no place for untrained men. Experience must be accompanied by technical knowledge.

A pioneer in home study, the International Correspondence Schools have kept pace with the times and offer courses which give practical instruction in fundamentals and latest developments alike. The courses were prepared and are constantly revised by the Who's Who of Radio!

Up to date in every respect, the Complete Radio Course covers the whole field of radio. The I. C. S. Radio Servicing Course was prepared specially for men who wish to become service experts, and win over competition. The I. C. S. Radio Operating Course is vital to mastery of operating and transmitting.

We will be pleased to send you details of any or all of these subjects. Just mark and mail the coupon—the information will be forwarded at once. Do it today—now!

INTERNATIONAL CORRESPONDENCE SCHOOLS

Box 6677-B, Scranton, Pa.

Without cost or obligation, please tell me all about the NEW RADIO COURSE

Name _____ Age _____

Street Address _____

City _____ State _____

If you reside in Canada, send this coupon to the International Correspondence Schools Canadian, Ltd., Montreal, Canada

FREE Radio Catalog

- (1)—FREE NEW CATALOG of Condensers, Transformers, Chokes, Sockets and general equipment for receiving and transmitting.
 - (2)—SEND 10c for New 32-page Manual of most popular Short-Wave Receivers, with illustrations, diagrams and parts lists.
- Address Dept. RC-10

HAMMARLUND MANUFACTURING CO.,
424-438 W. 33rd St., New York



THE LARGEST RADIO SUPPLY HOUSE IN THE WORLD

15th Anniversary Catalog NO. 59



RADIO PARTS

X-MITTING EQUIPMENT

P. A. EQUIPMENT

S. W. EQUIPMENT

The Biggest Book of Bargains in our History

CATALOGS

IN ONE

196-PAGES OF BARGAINS

MAIL THIS COUPON FOR YOUR COPY

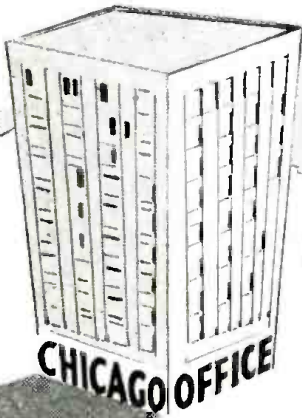

Read about our new Chicago office. 1 - 24 hour delivery throughout the entire west. Two large floors . . . 20,000 square feet.

Now! "Wholesale" celebrates its 15th Anniversary with the *Biggest Book of Bargains in History!* One giant catalog of 196 pages, crammed with thousands of items and hundreds of pictures. It really represents five separate catalogs going to the five key radio fields. Even if you had to pay for this catalog . . . you couldn't afford to miss it! So send for it right away. Our Birthday Bargains are bound to tickle you! Our prices . . . the lowest in history . . . sure to satisfy.

Wholesale Radio Service Co., Inc.
901-911 West Jackson Blvd.
Chicago, Illinois

Send for your free copy today!

WHOLESALE RADIO SERVICE CO.
Main Office and Warehouse
100 SIXTH AVENUE - NEW YORK, N.Y.

CHICAGO, ILL.
901-911 West Jackson Blvd.

ATLANTA, GA.
430 West Peachtree St.

WHOLESALE RADIO SERVICE CO., Inc.
100 Sixth Avenue
New York, N. Y. RC-105

Send me your new 1936 Catalog No. 59.

Name _____
Address _____
City _____ State _____

Please Say That You Saw It in RADIO-CRAFT

SAVE up to 50% by BUYING YOUR RADIO *Direct from* MIDWEST LABORATORIES

Exciting World-Wide Entertainment... Glorious New Acousti-Tone
Guaranteed with Amazing New 1936
SUPER Deluxe

MIDWEST



ONLY
RADIO COVERING
4½ TO 2,400 METERS.

30 Days FREE Trial!

18 Tube
SIX-IN-ONE Radio
ALL WAVE
6 TUNING RANGES

WORLD'S
GREATEST RADIO VALUE

\$59.50
with New
GIANT
THEATRE-
SONIC
(LESS TUBES) SPEAKER

TERMS AS LOW AS \$5.00 DOWN



PUSH-BUTTON TUNING
(Noises Suppressed)

Now, Push Button Silent Tuning is offered for first time! Simply pushing Silencer Button hushes set between stations... suppresses noises. Pressing Station Finder Button automatically indicates proper dial position for bringing in extremely weak stations.

Acousti-Tone V-Spread Design
(Patent Pending)

Establishes new radio style overnight! The V-Front Dispersing Vanes were developed by Midwest engineers as a result of a study of directional effect of the Midwest Full Scope High Fidelity Speaker. These Vanes spread the beautiful lacework of the "highs" throughout the entire room in a scientific manner... directing the High Fidelity waves uniformly to the ear. Send for new FREE 40-page catalog. It pictures the complete line of beautiful 1936 Acousti-Tone V-Spread consoles... and chassis... in four colors.

FULL SCOPE HIGH FIDELITY
Brilliant



Concert Tone
Now, get complete range of audible frequencies from 30 to 16,000 cycles, being transmitted by four new High Fidelity Broadcasting stations—W1XBS, W9XBY, W2XR and W6XAL. Glorious new Acousti-Tone is achieved... assuring life-like, crystal-clear "concert" realism.
V-FRONT

EVERYWHERE radio enthusiasts are saying: "Have you seen the new 18-tube, 6 tuning ranges, Acousti-Tone V-Spread Midwest?" It's an improvement over Midwest's 16-tube set, so popular last season. This amazingly beautiful, bigger, better, more powerful, super selective, 18-tube radio... is not obtainable in retail stores... but is sold direct to you from Midwest Laboratories at a positive saving of 30% to 50%. (This statement has been verified by a Certified Public Accountant!) Out-performs \$250.00 sets. Approved by over 120,000 customers. Before you buy any radio, write for FREE 40-page catalog. Never before so much radio for so little money. Why pay more? You are triple-protected with: One-Year Guarantee, Foreign Reception Guarantee and Money-Back Guarantee.

80 ADVANCED 1936 FEATURES

Scores of marvelous features, many exclusive, explain Midwest super performance and world-wide reception... enable Midwest to bring in weak distant foreign stations, with full loud speaker volume, on channels adjacent to locals. They prove why many orchestra leaders use Midwest radios to study types of harmony and rhythmic beats followed by leading American and foreign orchestras. Only Midwest tunes as low as 4½ meters... only Midwest offers push button tuning and Acousti-Tone V-spread design. See pages 12 to 20 in FREE catalog. Read about advantages of 6 tuning ranges—offered for first time—E, A, L, M, H and U... that make this super de luxe 18-tube set the equivalent of six different radios... offer tuning ranges not obtainable in other radios at any price.

DEAL DIRECT WITH
LABORATORIES

No middlemen's profits to pay—you buy at wholesale price direct from laboratories

SAVE
UP TO 50%

... saving 30% to 50%. Increasing costs are sure to result in higher radio prices soon. Buy before the big advance... NOW... while you can take advantage of Midwest's sensational values. You can order your 1936 Full Scope High Fidelity Acousti-Tone radio from the 40-page catalog with as much certainty of satisfaction as if you were to come yourself to our great radio laboratories. You save 30% to 50%... you get 30 days FREE trial... as little as \$5.00 puts a Midwest radio in your home. Satisfaction guaranteed or money back. Write today, for FREE catalog.

Two Strikes on Other Radios!

Chicago, Ill.—It's as big a thrill as smacking one over the fence to bring in distant foreign stations like locals. Midwest radios are the best obtainable and have two strikes on any other make.

Sam Mitchell "Gabby" Hartnett
(Chicago Cubs)



England, Spain, Italy,
Most Every Night

Washington, D. C.—We are more pleased with our Midwest every day. We tune in GSB, London—EAQ, Spain—DJC, Germany—12RO, Rome, etc., most every evening with local volume.
Robert H. Gerhardt.



METAL TUBES

This Midwest is furnished with the new glass-metal counterpart tubes. Set sockets are designed to accept glass-metal or METAL tubes, without change. Write for FREE facts.

MAIL COUPON TODAY! FOR
FREE 30-DAY TRIAL OFFER and 40-PAGE FOUR-COLOR FREE CATALOG

MIDWEST RADIO CORP., Dept. 12D, Cincinnati, Ohio.
Without obligation on my part, send me your new FREE catalog, complete details of your liberal 30-day FREE trial offer, and FREE Miniature Rotating 18-tube Dial. This is NOT an order.
User-Agents Make Easy Extra Money
Check Here for Details

Name _____
Address _____
Town _____ State _____
 Check here, if interested in a Midwest Auto Radio.

MIDWEST RADIO CORP.
DEPT. 12D CINCINNATI, OHIO U.S.A.
Established 1920 Cable Address MIRACO All Codes

Really stable

Short-Wave Reception

... with General Electric Receivers

For 1936, General Electric offers these notably new features that keep the set always at "concert pitch".

- All-metal tubes make possible higher R. F. gain with consequent great improvement in signal to noise ratio. (Important for short-wave reception.)
- Permaliners — The first production receiver equipped with air dielectric trimmer condensers that are individually enclosed and protected against moisture and dust.
- Short leads from tube elements to tuned circuit made possible by: —
New Metal Tubes
Coils Mounted Directly on Switch Points
- Good mechanical design — efficient placement of parts — self-shielding metal tubes and sentry box.



MODEL A-82 The chassis is specially designed to include every advantage that results from the use of metal tubes and short leads. It meets the exacting requirements of short-wave listeners and amateur operators. An extremely sensitive and selective four-band receiver, tuning 49, 31, 25, 19 and 16 meter bands. Eight metal tubes. Sentry Box. Permaliners. Sliding-rule Tuning Scale. Stabilized Dynamic Speaker. Noise Control. Automatic Lo-note Compensation. Power Output — 4 watts undistorted. Maximum Volume Output — 6 watts. CW Oscillator may be added.

\$94.50

(Eastern List Price)

MAIL THIS COUPON FOR OSCILLATOR DATA

General Electric Company, Bridgeport, Conn.
Attention: Sales Promotion Section R-7710,

Please send me Data Sheet FS-58 "Best Frequency Oscillator", and complete details of G-E Radios with the metal tubes.

Name.....

Street Address.....

City..... State.....



**GENERAL
ELECTRIC
RADIO**

MERCHANDISE DEPARTMENT, GENERAL
ELECTRIC CO., BRIDGEPORT, CONN.